

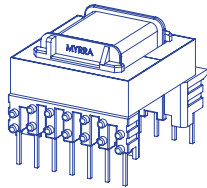

myrra.com



Switching Transformers Range

1W to 200W

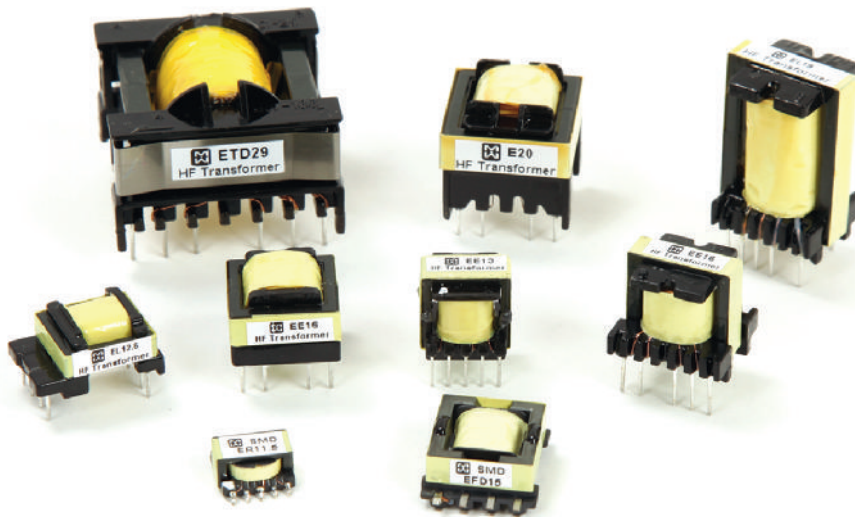

conforms to IEC60950 , IEC60335, IEC61558

*Bobbins footprint and pinout:
scale 1:1*

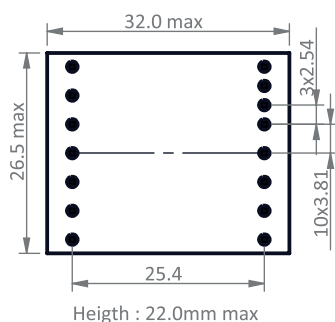

1W

2W

5W

10W

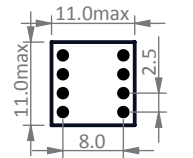
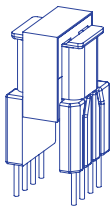

Height : 19.0mm max

E 10
reinforced insulation
creepage distances: 6mm

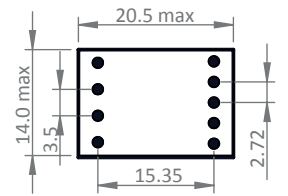
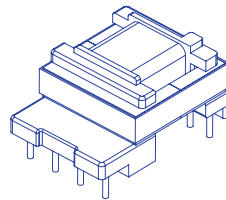

Height : 11mm max

EF 12.6
reinforced insulation
creepage distances: 6mm

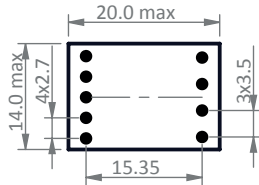
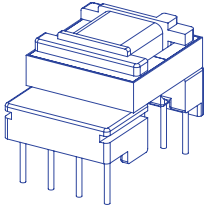

Height : 12.5mm max

EF 12.6
reinforced insulation
creepage distances: 6mm

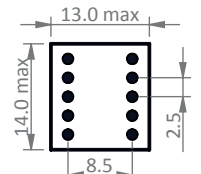
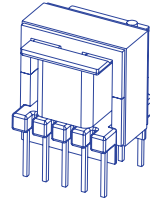

Height : 14.8mm max

E 13
basic insulation

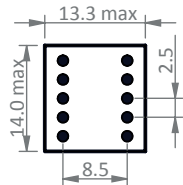
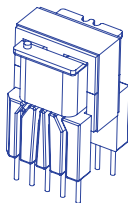

Height : 19.2mm max

E 13
reinforced insulation
creepage distances: 6mm

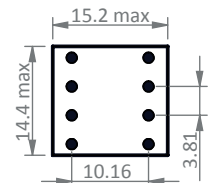
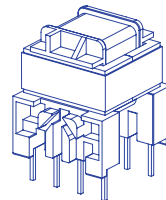

Height : 17.7mm max

E 13
reinforced insulation
creepage distances: 6mm

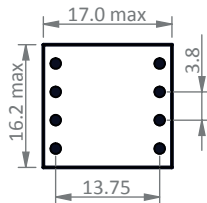
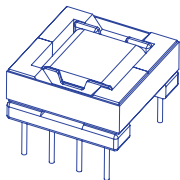

Height : 11mm max

EFD 15
basic insulation

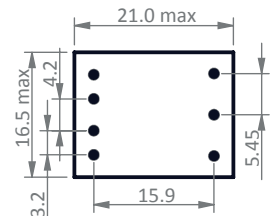
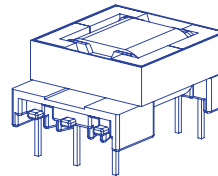

Height : 10.0mm max

EFD 15
reinforced insulation
creepage distances: 6mm

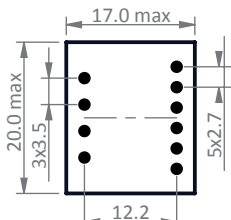
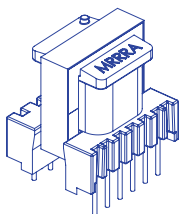

Height : 21.0 mm max

E 16
reinforced insulation
creepage distances: 6mm

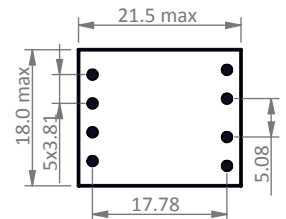
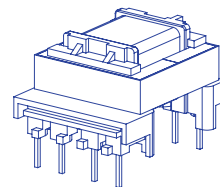

Height : 14.0mm max

EF 16
reinforced insulation
creepage distances: 6mm

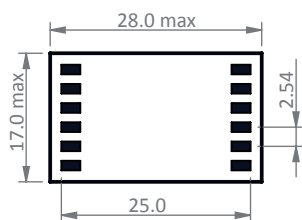
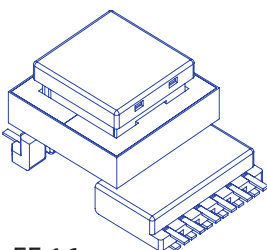

Height : 14.7mm max

EF 16
reinforced insulation
creepage distances: 6mm

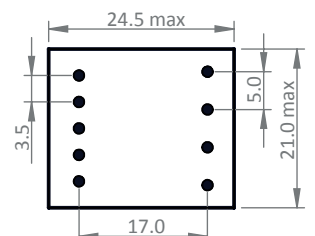
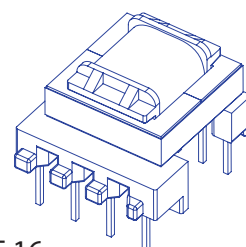

Height : 17mm max

EF 16
reinforced insulation
creepage distances: 6mm

20W

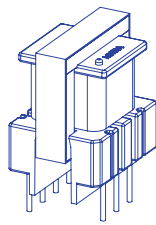

E 19
reinforced insulation
creepage distances: 6mm

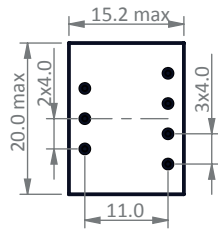

Height : 23.5mm max

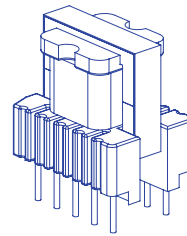

E 19
reinforced insulation
creepage distances: 6mm

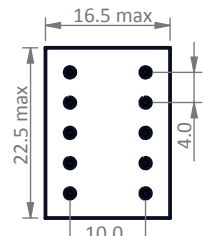

Height : 23.5mm max

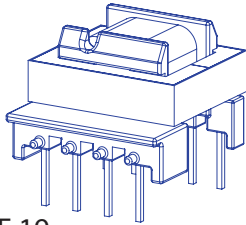

E 19
reinforced insulation
creepage distances: 6mm

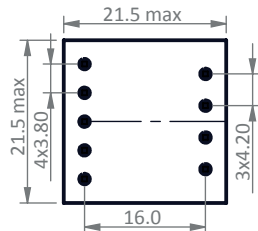

Height : 15.0mm max

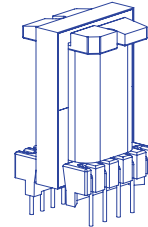

EL 19
reinforced insulation
creepage distances: 6mm

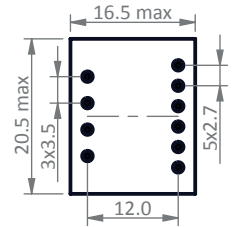

Height : 31.0mm max

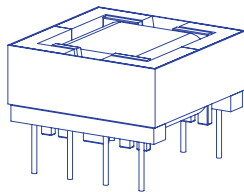

EFD 20
basic insulation

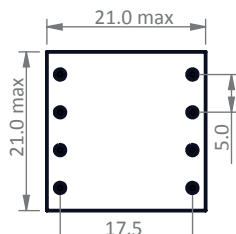

Height : 11.0mm max

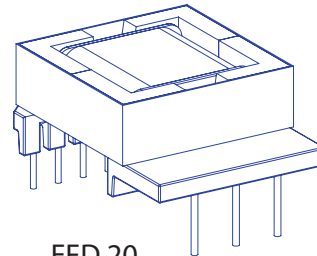

EFD 20
reinforced insulation
creepage distances: 6mm

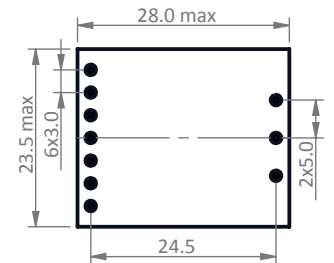

Height : 11.5mm max

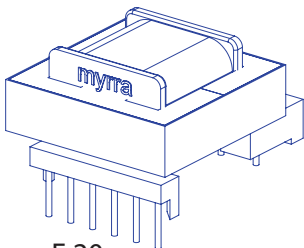

E 20
reinforced insulation
creepage distances: 6mm

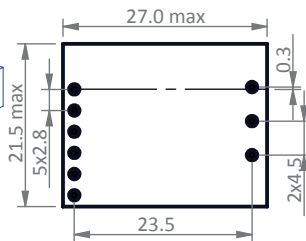

Height : 13.0mm max

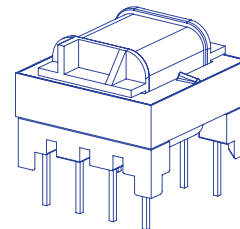

EF 20
basic insulation

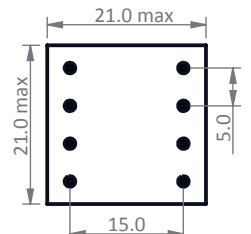

Height : 16.0mm max

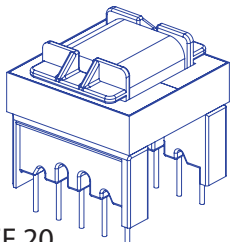

EF 20
reinforced insulation
creepage distances: 6mm

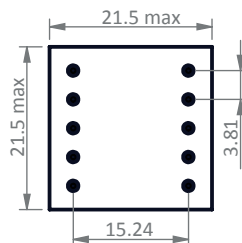

Height : 21.0mm max

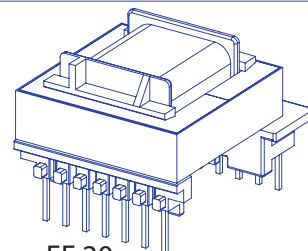

EF 20
reinforced insulation
creepage distances: 8mm

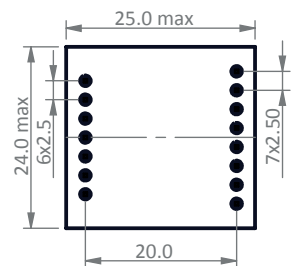

Height : 16.0mm max

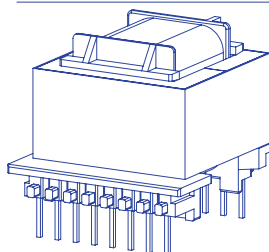

EF 20/11
reinforced insulation
creepage distances: 6mm

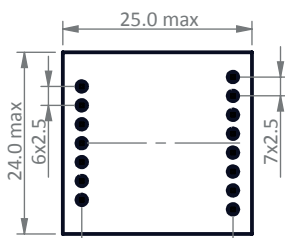

Height : 22.0mm max

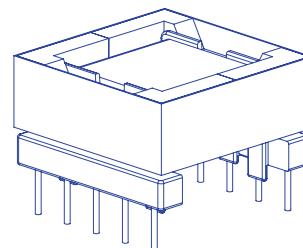

EFD 25
basic insulation

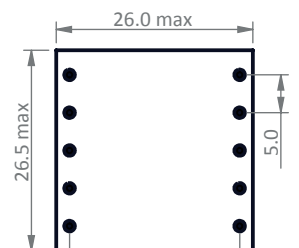

Height : 16.0mm max

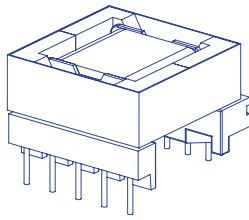

EFD 25
reinforced insulation
creepage distances: 6mm

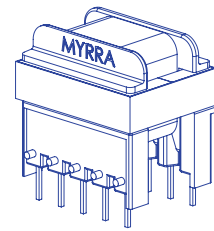
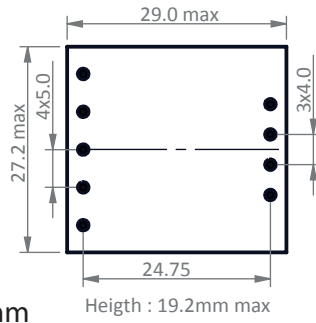

E 25
reinforced insulation
creepage distances: 8mm

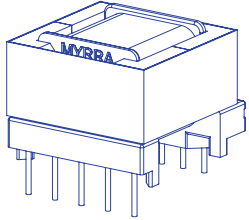
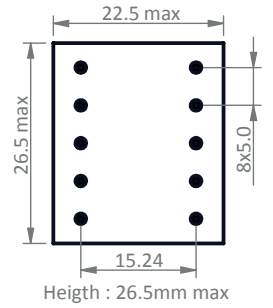

EVD 25
reinforced insulation
creepage distances: 6mm

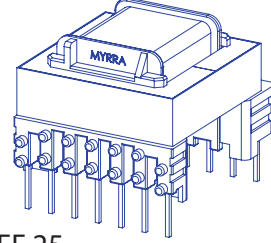
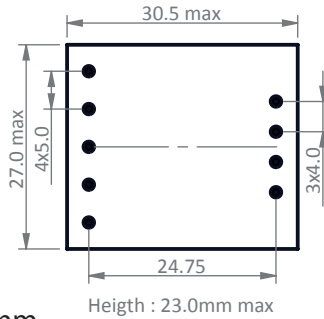

EF 25
reinforced insulation
creepage distances: 8mm

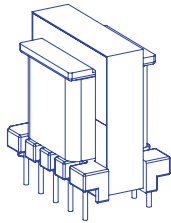
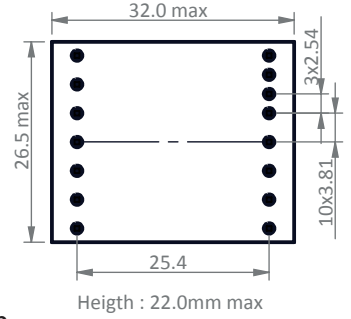

EF 25
reinforced insulation
creepage distances: 6mm

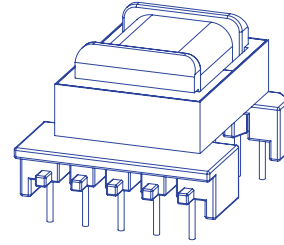
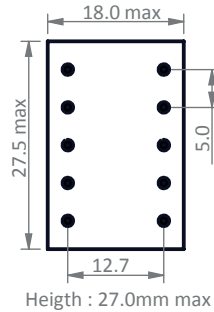

EF 25
reinforced insulation
creepage distances: 6mm

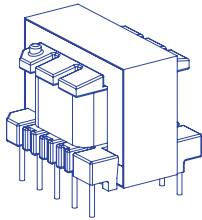
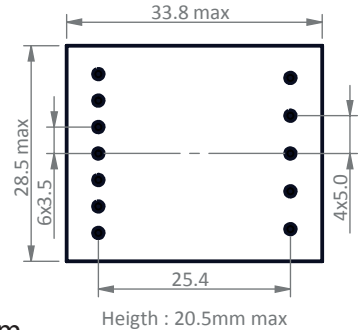

EI 28
reinforced insulation
creepage distances: 6mm

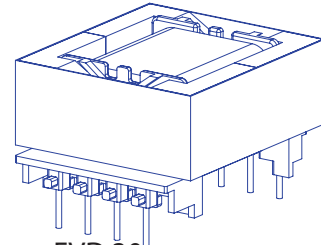
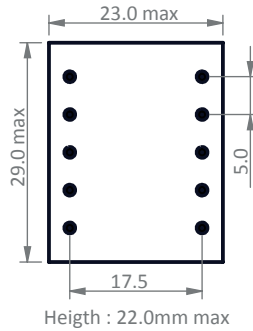

EVD 30
reinforced insulation
creepage distances: 6mm

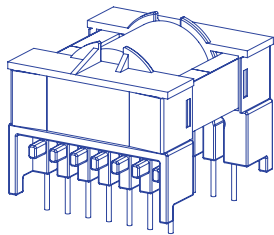
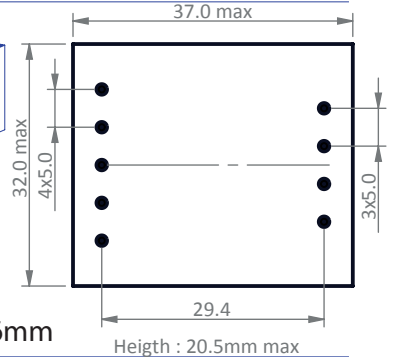

ETD Horizontal
reinforced insulation
creepage distances: 6mm

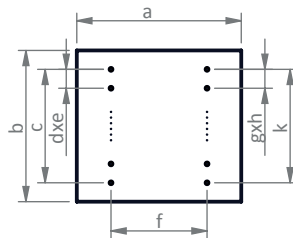

unit:mm

Size	Pin Qty.	a (max)	b (max)	c	dx	f	gx	h	k	height (max)
ETD29	7+7	36.5	36.5	30.48	6x5.08	25.4	6x5.08	30.48	30.48	25.5
ETD34	7+7	43.0	41.0	30.0	6x5.0	25.5	6x5.0	30.0	30.0	34.5
ETD39	8+8	45.0	45.0	35.0	7x5.0	30.2	7x5.0	35.0	35.0	34.0
ETD44	9+9	52.5	50.0	40.0	8x5.0	35.56	8x5.0	40.0	40.0	40.0
ETD49	10+10	58.0	57.0	45.0	9x5.0	40.8	9x5.0	45.0	45.0	43.5

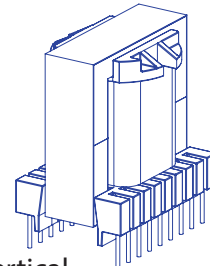

ETD Vertical
reinforced insulation
creepage distances: 6mm

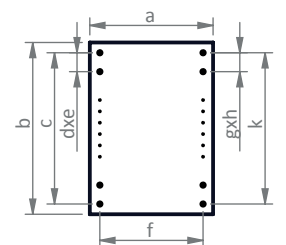

unit:mm

Size	Pin Qty.	a (max)	b (max)	c	dx	f	gx	h	k	height (max)
ETD29	7+7	25.0	35.5	30.48	6x5.08	20.32	6x5.08	30.48	30.48	41.5
ETD34	7+7	28.0	35.5	30.48	6x5.08	22.85	6x5.08	30.48	30.48	35.5
ETD39	8+8	31.5	41.0	35.0	7x5.0	25.4	7x5.0	35.0	35.0	47.0
ETD44	9+9	33.5	46.0	40.0	8x5.0	27.5	8x5.0	40.0	40.0	51.0
ETD49	11+11	50.0	68.2	50.8	10x5.08	33.02	10x5.08	50.8	50.8	72.5

50W

100W

200W