

TRANSFORMERS & INDUCTORS



MYRRA
...Of course !

COMPANY PROFILE

Myrra is a major supplier in high quality for electronics components. Myrra has established a worldwide reputation. Myrra design and manufacture high-quality transformers and inductors for industrial use. We supply a blue-chip customer base in a variety of industries, including energy conversion, industrial applications, renewable energy and healthcare. We supply customers all over the world.

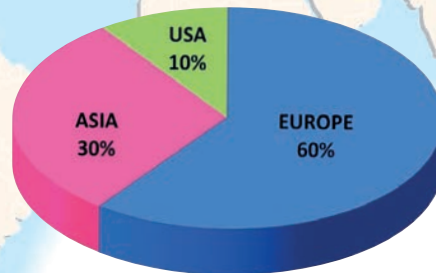

A wide range of products : We offer application specific transformers, inductors, chokes and coils, in three technologies: high frequency, 50Hz technology and electronic, enabling us to serve a number of major markets.

MAGNETICS PRODUCTS

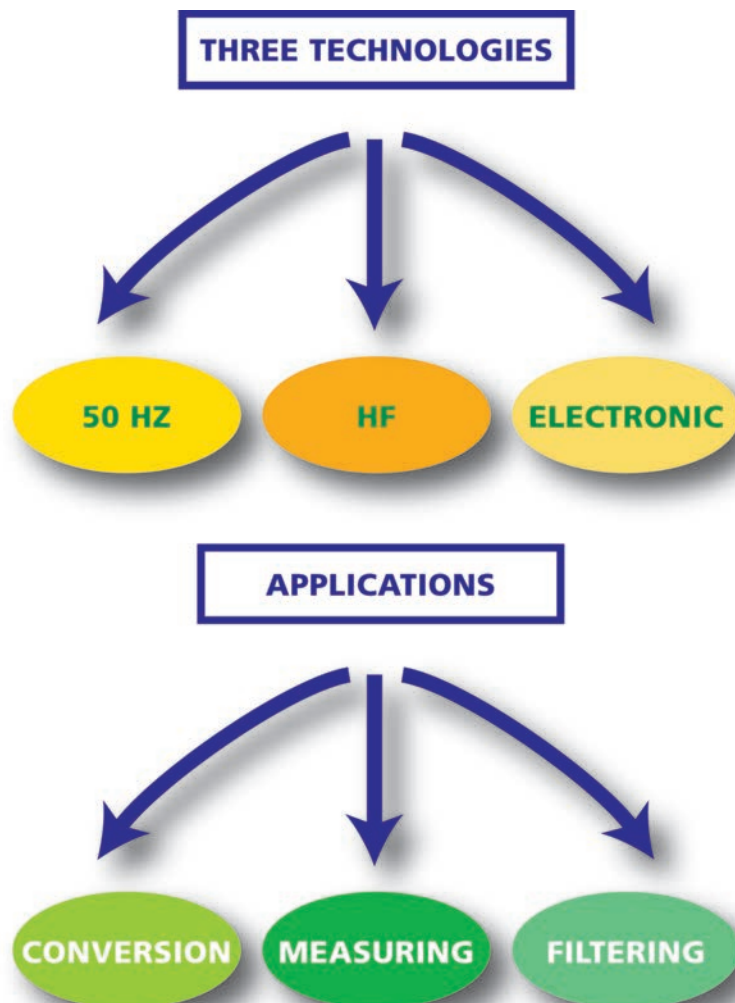



PRODUCT LINES



PCB MAGNETIC COMPONENTS

Encapsulated 50Hz transformers (44 & 45 series)

- * Full range of standard references
- * Isolating safety application
- * UL, VDE, EN61558 certification
- * Automated - 100% tested production

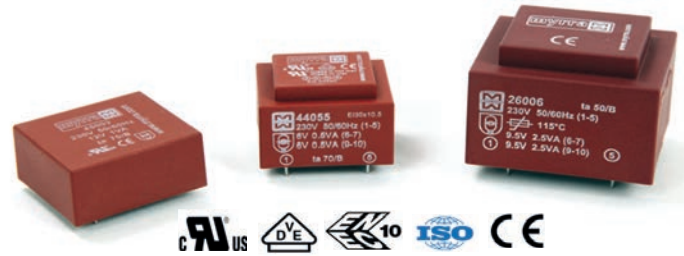

Ferrites core transformers & inductors (74 series)

- * Large application range : flyback transformers, CM chokes etc.
- * International standards compliant
- * Standard products and customized design



Conform to IEC950 IEC335 IEC61558

IT application inductors -THC- SMD type (75-79 series)



Encapsulated POWER SUPPLY (47 series)

- * Pioneering alternative to linear transformers in AC/DC application
- * E130 to E148 size - Input range : 85V-265VAC
- * Regulated output: 3.3VDC-24VDC/ 2.5W-5W-7W-10W-20W-40W-60W
- * Full compliance with Safety, EMC and Immunity standards

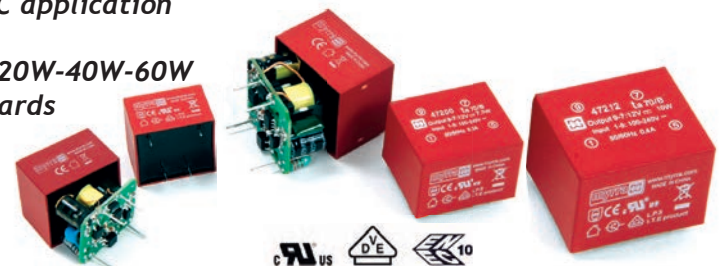

POWER RANGE Transformers and Chokes for specific applications

Lamination and ferrite core

- * Customized design on specification
- * Up to 50kVA for 1000V input range
- * Insulation systems : B, F, H classes
- * UL, IEC, CSA Compliant



Low frequency, High frequency



ISO 9001 2008
ISO 14000



EN60950

EN61558-2-6

MYRRA FRANCE (HQ)

MYRRA DEUTSCHLAND

MYRRA POLAND

MYRRA TURKEY

MYRRA HISPANIA

MYRRA HONG-KONG

MYRRA ZHONGSHAN (China)

YOUR CONTACT :

Name

Phone

Email



P R O D U C T I N D E X



| | |
|---|----------|
| TECHNICAL INFORMATIONS | 4 |
| ■ ENCAPSULATED TRANSFORMERS | 5 to 25 |
| 44000 SERIES | |
| 0.6 VA to 2.8VA / EI30-5 to EI30-18 | 5 to 13 |
| 3.2VA to 30 VA / EI38 to EI66 | 14 to 19 |
| WITH OTHER BOXES | 20 |
| 45000 SERIES | |
| 1 VA to 60 VA | 21 to 24 |
| FLF / FLC SERIES | |
| 3.2 VA to 240 VA | 25 |
| ■ HIGH FREQUENCY FERRITE | 26 to 75 |
| POWER FERRITE TRANSFORMERS | 26 to 50 |
| FLYBACK TRANSFORMERS RANGE | 26 |
| TRANSFORMERS / CONTROL CIRCUITS CROSS REFERENCE LIST | 27 |
| 1 W to 12 W EE16 | 28 to 38 |
| 10 W to 30 W EL19 EF20 EE25 | 39 to 42 |
| 35 W to 180 W ETD29 to ETD44 ERL28 | 43 to 47 |
| FLYBACK TRANSFORMERS STANDARD SIZES | 48 to 50 |
| COMMON MODE CHOKES FOR EMI SUPPRESSION | 51 to 55 |
| TOROIDAL CHOKES | 56 |
| CURRENT TRANSFORMERS RANGE | 57 to 68 |
| PULSE TRANSFORMER RANGE | 69 to 74 |
| POWER LINE COMMUNICATION COUPLING TRANSFORMERS | 75 to 77 |
| ■ THROUGH HOLES CHOKES / SURFACE MOUNT CHOKES | 78 |
| ■ ENCAPSULATED POWER SUPPLY | 79 to 81 |
| ■ CUSTOM POWER PRODUCTS | to 84 |

TECHNICAL INFORMATION

RATED PRIMARY VOLTAGE (V)

This is the supply voltage assigned to the transformer by the manufacturer.

RATED SECONDARY VOLTAGE (V)

This is the secondary output voltage assigned to the transformer when supplied with the rated primary voltage, frequency range, rated secondary current, all assigned by the manufacturer for the specified operating conditions of the transformer.

RATED POWER (VA)

The specified power levels in this catalogue are the secondary power levels, in other words, those available when the transformer is loaded. It is the product of the RMS rated secondary voltage by the RMS rated current. If the transformer has more than one output winding, the rated power denotes the maximum sum of the products of RMS rated secondary voltage by the RMS rated secondary current, respectively. This rated power is defined for rated ambient temperature conditions.

example : $P = 3,2 \text{ VA ta } 70/B$

The transformer can deliver 3.2VA at maximum ambient (70°C), the load consisting of a resistor load defined by $R(\text{load}) = U(\text{sec})^2/P$ (assigned U sec & P values), heating does not exceed the relevant limit for Class B components used in this construction.

NOTE : When the transformer is intended to supply DC voltage and current in conjunction with rectifiers and smoothing capacitors, the VA power required from the transformer is far higher than the $U(\text{DC})$ and $I(\text{DC})$ product. To help you to determine the true transformer power, our Technical Department is at your disposal.

AMBIENT TEMPERATURE (ta)

The maximum temperature at which the transformer may be operated continuously under nominal conditions of use. It is the air temperature measured close to the transformer after thermal stabilization when operating at rated conditions.

HEATING

The increase of the winding temperature when operating at rated conditions and maximum ambient temperature. The heating must be determined by the resistance method.

TEMPERATURE CLASS

The international classification of temperature classes is as follows :

| | | | |
|---|-------|-----|--------|
| A | 105°C | H | 180 °C |
| E | 120°C | 200 | 200 °C |
| B | 130°C | 220 | 220 °C |
| F | 155°C | 250 | 250 °C |

It defines the maximum temperature the transformer components must withstand in continuous operation, in compliance with the N° 85 IEC publication classification. There insulating materials are therefore certificated for the thermal index corresponding to the declared class in accordance with N° 216 IEC standard.

PARTICULAR POINTS OF EN 61558-2-6 STANDARD FOR SAFETY TRANSFORMERS

On-load secondary voltage tolerance.

This should not differ from the rated value by more than :

10% for transformers with build-in resistance to short-circuits (a supplement of 5% is granted on the 2nd secondary for transformers with 2 secondaries).

5% for other transformers whatever the secondaries number.

Off-load secondary voltage.

The values given in this catalogue are maximum theoretical values.

NOTE : For safety transformers, this should never exceed 50 V rms. In the case of a transformer with several secondaries, the sum of the secondary voltages should be less than 50 V rms.

ADAPTED TRANSFORMERS FROM THE STANDARDS SERIES

Any transformer whose requires Power and Ambient corresponding to those of our 44000 & 45000 range, and whose secondary voltage can fit in our minimum to maximum secondary range will be covered by EN61558-2-6, EN60950, or UL506 approvals, depending on the effective choice .

SPECIAL TRANSFORMERS

MYRRA can use the 44000, 45000 or 46000 standard ranges to examine any transformer for compliance with your specifications and with international standards.

On request, we can add thermal protection, thermal fuse, thermal switch-CTP.

In certain cases, the addition of thermal protection enables the ambient temperature to be increased, while still complying with EN 61558.

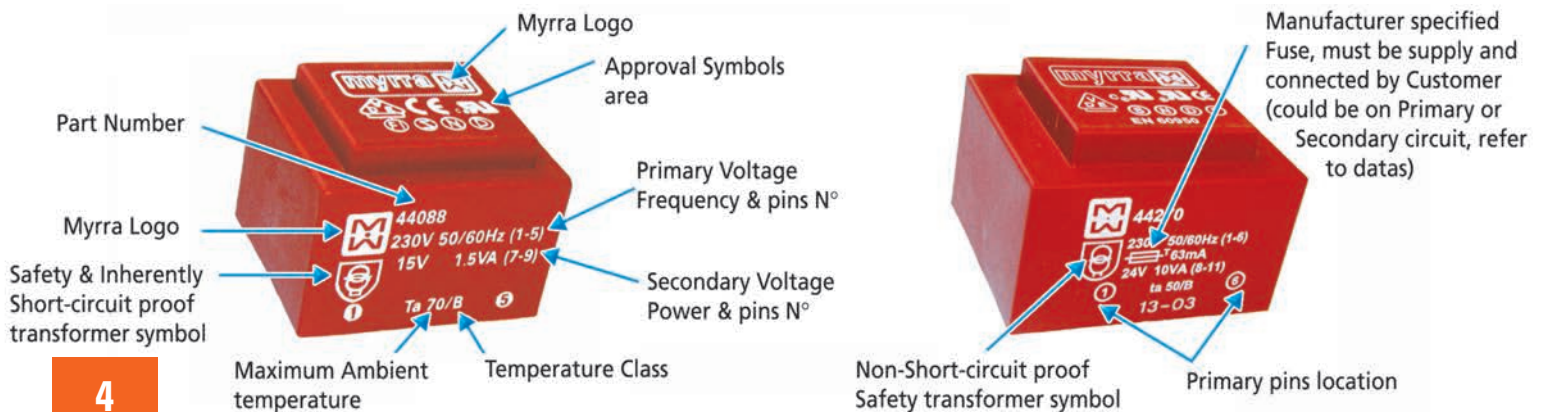



- Vacuum filling
- Two compartments bobbins
- Self-extinguishing plastics UL 94 V0
- Degree of protection IP 00
- 40 grams weight
- Resin class B CEI 85 (20 000 h testing to CEI 126)
- Inherently short-circuits proof
- Insulation voltage 4 KV
- 100 % tested production
- Certification : CCA procedure on request

QUALITY IN SERIES

PRIMARY VOLTAGE 117 V

| Protection | Reference | Secondary voltage V | Secondary current mA | No-load voltage V | Ambient Temperature °C | Rating VA |
|------------|-----------|---------------------|----------------------|-------------------|------------------------|-----------|
| | 44025 | 6 | 100 | 9,94 | T 70 B | 0,6 |
| | 44026 | 9 | 66 | 14,95 | T 70 B | 0,6 |
| | 44027 | 12 | 50 | 19,9 | T 70 B | 0,6 |
| | 44028 | 15 | 40 | 24,9 | T 70 B | 0,6 |
| | 44029 | 18 | 33 | 29,9 | T 70 B | 0,6 |
| | 44030 | 24 | 25 | 39,8 | T 70 B | 0,6 |
| | 44031 | 2 x 6 | 2 x 50 | 2 x 9,94 | T 70 B | 0,6 |
| | 44032 | 2 x 9 | 2 x 33 | 2 x 14,95 | T 70 B | 0,6 |
| | 44033 | 2 x 12 | 2 x 25 | 2 x 19,9 | T 70 B | 0,6 |
| | 44034 | 2 x 15 | 2 x 20 | 2 x 24,9 | T 70 B | 0,6 |
| | 44035 | 2 x 18 | 2 x 17 | 2 x 29,9 | T 70 B | 0,6 |
| | 44036 | 2 x 24 | 2 x 12 | 2 x 39,8 | T 70 B | 0,6 |

PRIMARY VOLTAGE 230 V

| Protection | Reference | Secondary voltage V | Secondary current mA | No-load voltage V | Ambient Temperature °C | Rating VA |
|------------|-----------|---------------------|----------------------|-------------------|------------------------|-----------|
| | 44013 | 6 | 100 | 9,94 | T 70 B | 0,6 |
| | 44014 | 9 | 66 | 14,95 | T 70 B | 0,6 |
| | 44015 | 12 | 50 | 19,9 | T 70 B | 0,6 |
| | 44016 | 15 | 40 | 24,9 | T 70 B | 0,6 |
| | 44017 | 18 | 33 | 29,9 | T 70 B | 0,6 |
| | 44018 | 24 | 25 | 39,8 | T 70 B | 0,6 |
| | 44019 | 2 x 6 | 2 x 50 | 2 x 9,94 | T 70 B | 0,6 |
| | 44020 | 2 x 9 | 2 x 33 | 2 x 14,95 | T 70 B | 0,6 |
| | 44021 | 2 x 12 | 2 x 25 | 2 x 19,9 | T 70 B | 0,6 |
| | 44022* | 2 x 15 | 2 x 20 | 2 x 24,9 | T 70 B | 0,6 |
| | 44023* | 2 x 18 | 2 x 17 | 2 x 29,9 | T 70 B | 0,6 |
| | 44024* | 2 x 24 | 2 x 12 | 2 x 39,8 | T 70 B | 0,6 |

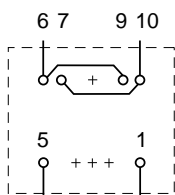
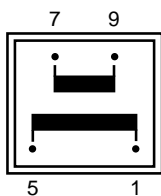

Recommended layout for transformers with 1 secondary winding (Allows the use of a transformer with 2 secondary windings)

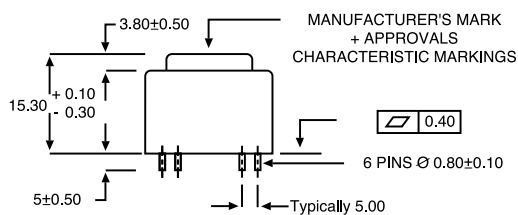
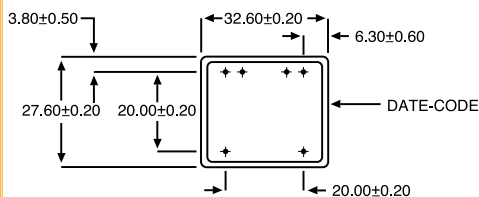
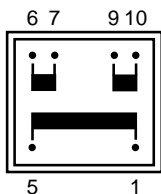

** RECOMMENDED DRILL-HOLE DIAMETER FOR 1,3 mm PINS



PRIMARY VOLTAGE 117 V

| Protection | Reference | Secondary voltage V | Secondary current mA | No-load voltage V | Ambient Temperature °C | Rating VA |
|------------|-----------|---------------------|----------------------|-------------------|------------------------|-----------|
| | 44061 | 6 | 167 | 8,6 | T 70 B | 1 |
| | 44062 | 9 | 111 | 12,9 | T 70 B | 1 |
| | 44063 | 12 | 83 | 17,2 | T 70 B | 1 |
| | 44064 | 15 | 67 | 21,6 | T 70 B | 1 |
| | 44065 | 18 | 56 | 25,9 | T 70 B | 1 |
| | 44066 | 24 | 42 | 37,9 | T 70 B | 1 |
| | 44067 | 2 X 6 | 2 x 83 | 2 x 8,6 | T 70 B | 1 |
| | 44068 | 2 x 9 | 2 x 56 | 2 x 12,9 | T 70 B | 1 |
| | 44069 | 2 x 12 | 2 x 42 | 2 x 19 | T 70 B | 1 |
| | 44070 | 2 x 15 | 2 x 33 | 2 x 23,6 | T 70 B | 1 |
| | 44071 | 2 x 18 | 2 x 28 | 2 x 24,9 | T 70 B | 1 |
| | 44072 | 2 x 24 | 2 x 21 | 2 x 37,9 | T 70 B | 1 |

EN 61558-2-6

- Vacuum filling
- Two compartments bobbins
- Self-extinguishing plastics UL 94 V0
- Degree of protection IP 00
- 70 grams weight
- Resin class B CEI 85 (20 000 h testing to CEI 126)
- Inherently short-circuits proof
- 30 V and 36 V models are VDE EN 61558-2-6 certified (production on request)

| | | | | | | |
|--|--------|--------|-----|----------|---------|-----|
| | 44338 | 6 | 250 | 10,1 | ta 70/B | 1,5 |
| | 44339 | 9 | 167 | 15,3 | ta 70/B | 1,5 |
| | 44340 | 12 | 125 | 20,2 | ta 70/B | 1,5 |
| | 44341 | 15 | 100 | 25,3 | ta 70/B | 1,5 |
| | 44342 | 18 | 83 | 31,2 | ta 70/B | 1,5 |
| | 44343 | 24 | 63 | 43,3 | ta 70/B | 1,5 |
| | 44344 | 2 x 6 | 125 | 2 x 10,1 | ta 70/B | 1,5 |
| | 44345 | 2 x 9 | 83 | 2 x 15,3 | ta 70/B | 1,5 |
| | 44346 | 2 x 12 | 63 | 2 x 20,2 | ta 70/B | 1,5 |
| | 44347 | 2 x 15 | 50 | 2 x 25,0 | ta 70/B | 1,5 |
| | 44348* | 2 x 18 | 42 | 2 x 31 | ta 70/B | 1,5 |
| | 44349* | 2 x 24 | 31 | 2 x 43 | ta 70/B | 1,5 |

| | | | | | | |
|--|-------|--------|---------|----------|---------|-----|
| | 44840 | 6 | 300 | 10,1 | ta 70/B | 1,8 |
| | 44841 | 9 | 200 | 15,2 | ta 70/B | 1,8 |
| | 44842 | 12 | 150 | 20,3 | ta 70/B | 1,8 |
| | 44843 | 15 | 120 | 27,3 | ta 70/B | 1,8 |
| | 44844 | 18 | 100 | 30,4 | ta 70/B | 1,8 |
| | 44845 | 24 | 75 | 40,6 | ta 70/B | 1,8 |
| | 44846 | 2 x 6 | 2 x 150 | 2 x 10,1 | ta 70/B | 1,8 |
| | 44847 | 2 x 9 | 2 x 100 | 2 x 15,2 | ta 70/B | 1,8 |
| | 44848 | 2 x 12 | 2 x 75 | 2 x 20,3 | ta 70/B | 1,8 |
| | 44849 | 2 x 15 | 2 x 60 | 2 x 27,3 | ta 70/B | 1,8 |

1 Secondary winding

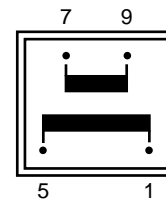

Primary winding

2 Secondary windings

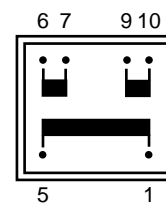

Primary winding

Recommended layout for transformers with 1 secondary winding

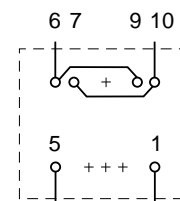

(Allows the use of a transformer with 2 secondary windings)



EN 60950 UL 5085 

- Insulation voltage 4 KV
- 100 % tested production
- Certification : CCA procedure on request

*To be noted 2 x 15 V and 2 x 24 V models are non-approved.
Those transformers meet all requirement of EN 61558-2-4

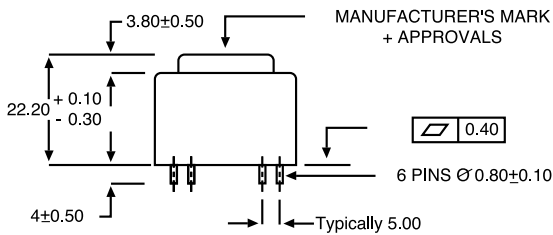
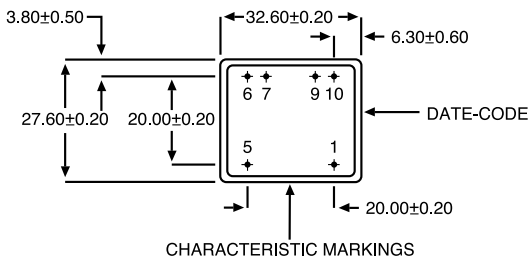



** RECOMMENDED DRILL-HOLE DIAMETER FOR 1,3 mm PINS

PRIMARY VOLTAGE 230 V

| Protection | Reference | Secondary voltage V | Secondary current mA | No-load voltage V | Ambient Temperature °C | Rating VA |
|---|-----------|---------------------|----------------------|-------------------|------------------------|-----------|
|  | 44049* | 6 | 167 | 8,6 | T 70 B | 1 |
| | 44050* | 9 | 111 | 12,9 | T 70 B | 1 |
| | 44051* | 12 | 83 | 17,2 | T 70 B | 1 |
| | 44052* | 15 | 67 | 21,6 | T 70 B | 1 |
| | 44053* | 18 | 56 | 25,9 | T 70 B | 1 |
| | 44054* | 24 | 42 | 37,9 | T 70 B | 1 |
| | 44055* | 2 x 6 | 2 x 83 | 2 x 8,6 | T 70 B | 1 |
| | 44056* | 2 x 9 | 2 x 56 | 2 x 12,9 | T 70 B | 1 |
| | 44057* | 2 x 12 | 2 x 42 | 2 x 19 | T 70 B | 1 |
| | 44058* | 2 x 15 | 2 x 33 | 2 x 23,6 | T 70 B | 1 |
| | 44059* | 2 x 18 | 2 x 28 | 2 x 24,9 | T 70 B | 1 |
| | 44060** | 2 x 24 | 2 x 21 | 2 x 37,9 | T 70 B | 1 |

* Items usually available on stock

| | | | | | | |
|---|--------|--------|-----|----------|---------|-----|
|  | 44326 | 6 | 250 | 10,1 | ta 70/B | 1,5 |
| | 44327 | 9 | 167 | 15,3 | ta 70/B | 1,5 |
| | 44328 | 12 | 125 | 20,2 | ta 70/B | 1,5 |
| | 44329 | 15 | 100 | 25,3 | ta 70/B | 1,5 |
| | 44330 | 18 | 83 | 31,2 | ta 70/B | 1,5 |
| | 44331 | 24 | 63 | 43,3 | ta 70/B | 1,5 |
| | 44332 | 2 x 6 | 125 | 2 x 10,1 | ta 70/B | 1,5 |
| | 44333 | 2 x 9 | 83 | 2 x 15,3 | ta 70/B | 1,5 |
| | 44334 | 2 x 12 | 63 | 2 x 20,2 | ta 70/B | 1,5 |
| | 44335 | 2 x 15 | 50 | 2 x 25,0 | ta 70/B | 1,5 |
| | 44336* | 2 x 18 | 42 | 2 x 31 | ta 70/B | 1,5 |
| | 44337* | 2 x 24 | 31 | 2 x 43 | ta 70/B | 1,5 |

| | | | | | | |
|---|--------|--------|---------|----------|---------|-----|
|  | 44830 | 6 | 300 | 10,1 | ta 70/B | 1,8 |
| | 44831 | 9 | 200 | 15,2 | ta 70/B | 1,8 |
| | 44832 | 12 | 150 | 20,3 | ta 70/B | 1,8 |
| | 44833 | 15 | 120 | 27,3 | ta 70/B | 1,8 |
| | 44834 | 18 | 100 | 30,4 | ta 70/B | 1,8 |
| | 44835 | 24 | 75 | 40,6 | ta 70/B | 1,8 |
| | 44836 | 2 x 6 | 2 x 150 | 2 x 10,1 | ta 70/B | 1,8 |
| | 44837 | 2 x 9 | 2 x 100 | 2 x 15,2 | ta 70/B | 1,8 |
| | 44838 | 2 x 12 | 2 x 75 | 2 x 20,3 | ta 70/B | 1,8 |
| | 44839* | 2 x 15 | 2 x 60 | 2 x 27,3 | ta 70/B | 1,8 |



PRIMARY VOLTAGE 117 V

| Protection | Reference | Secondary voltage V | Secondary current mA | No-load voltage V | Ambient Temperature °C | Rating VA |
|------------|-----------|---------------------|----------------------|-------------------|------------------------|-----------|
| | 44097 | 6 | 250 | 9,7 | T 70 B | 1,5 |
| | 44098 | 9 | 167 | 14,5 | T 70 B | 1,5 |
| | 44099 | 12 | 125 | 19,3 | T 70 B | 1,5 |
| | 44100 | 15 | 100 | 24,2 | T 70 B | 1,5 |
| | 44101 | 18 | 83 | 29,8 | T 70 B | 1,5 |
| | 44102 | 24 | 63 | 38,6 | T 70 B | 1,5 |
| | 44103 | 2 X 6 | 2 x 125 | 2 x 9,7 | T 70 B | 1,5 |
| | 44104 | 2 x 9 | 2 x 83 | 2 x 15 | T 70 B | 1,5 |
| | 44105 | 2 x 12 | 2 x 63 | 2 x 19,3 | T 70 B | 1,5 |
| | 44106 | 2 x 15 | 2 x 50 | 2 x 24,2 | T 70 B | 1,5 |
| | 44107 | 2 x 18 | 2 x 42 | 2 x 29 | T 70 B | 1,5 |
| 44108 | 2 x 24 | 2 x 31 | 2 x 38,6 | T 70 B | 1,5 | |



- Vacuum filling
- Two compartments bobbins
- Self-extinguishing plastics UL 94 V0
- Degree of protection IP 00
- 80 grams weight
- Resin class B CEI 85 (20 000 h testing to CEI 126)
- Inherently short-circuits proof
- 30 V model is VDE EN 61558-2-6 certified (production on request)

| | | | | | | |
|--|-------|--------|---------|----------|--------|-----|
| | 44726 | 6 | 283 | 9,8 | T 50 B | 1,7 |
| | 44727 | 9 | 189 | 14,8 | T 50 B | 1,7 |
| | 44728 | 12 | 142 | 19,7 | T 50 B | 1,7 |
| | 44729 | 15 | 113 | 24,6 | T 50 B | 1,7 |
| | 44730 | 18 | 94 | 30,3 | T 50 B | 1,7 |
| | 44731 | 24 | 71 | 39,3 | T 50 B | 1,7 |
| | 44732 | 2 x 6 | 2 x 142 | 2 x 9,8 | T 50 B | 1,7 |
| | 44733 | 2 x 9 | 2 x 94 | 2 x 15,2 | T 50 B | 1,7 |
| | 44734 | 2 x 12 | 2 x 71 | 2 x 19,7 | T 50 B | 1,7 |
| | 44735 | 2 x 15 | 2 x 57 | 2 x 24,6 | T 50 B | 1,7 |
| | 44736 | 2 x 18 | 2 x 47 | 2 x 29,5 | T 50 B | 1,7 |
| | 44737 | 2 x 24 | 2 x 35 | 2 x 39,3 | T 50 B | 1,7 |

| | | | | | | |
|--|-------|--------|---------|----------|--------|-----|
| | 44738 | 6 | 300 | 9,8 | T 40 B | 1,8 |
| | 44739 | 9 | 200 | 14,8 | T 40 B | 1,8 |
| | 44740 | 12 | 150 | 19,7 | T 40 B | 1,8 |
| | 44741 | 15 | 120 | 24,6 | T 40 B | 1,8 |
| | 44742 | 18 | 100 | 30,3 | T 40 B | 1,8 |
| | 44743 | 24 | 75 | 39,3 | T 40 B | 1,8 |
| | 44744 | 2 x 6 | 2 x 150 | 2 x 9,8 | T 40 B | 1,8 |
| | 44745 | 2 x 9 | 2 x 100 | 2 x 15,2 | T 40 B | 1,8 |
| | 44746 | 2 x 12 | 2 x 75 | 2 x 19,7 | T 40 B | 1,8 |
| | 44747 | 2 x 15 | 2 x 60 | 2 x 24,6 | T 40 B | 1,8 |
| | 44748 | 2 x 18 | 2 x 50 | 2 x 29,5 | T 40 B | 1,8 |
| | 44749 | 2 x 24 | 2 x 38 | 2 x 39,3 | T 40 B | 1,8 |

1 Secondary winding

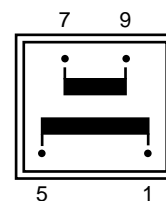

Primary winding

2 Secondary windings

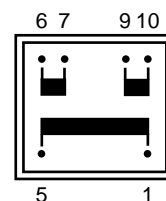

Primary winding

Recommended layout for transformers with 1 secondary winding

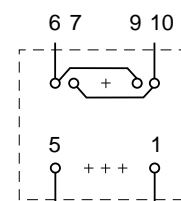

(Allows the use of a transformer with 2 secondary windings)

QUALITY IN SERIES



EN 60950 UL 5085 

- Insulation voltage 4 KV
- 100 % tested production
- Certification : CCA procedure on request

*To be noted : 2 x 18 V and 2 x 24 V models are non-approved.
Those transformers meet all requirement of EN 61558-2-4

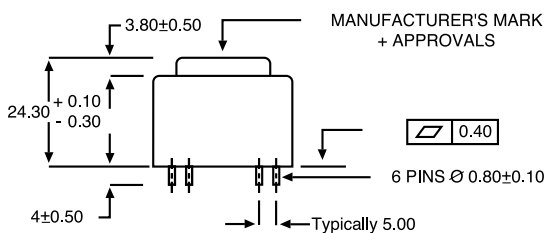
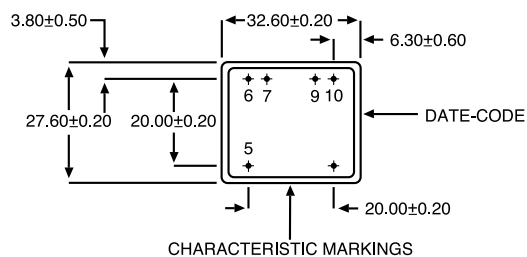



** RECOMMENDED DRILL-HOLE DIAMETER FOR 1,3 mm PINS

PRIMARY VOLTAGE 230 V

| Protection | Reference | Secondary voltage V | Secondary current mA | No-load voltage V | Ambient Temperature °C | Rating VA |
|---|-----------|---------------------|----------------------|-------------------|------------------------|-----------|
|  | 44085* | 6 | 250 | 9,7 | T 70 B | 1,5 |
| | 44086* | 9 | 167 | 14,5 | T 70 B | 1,5 |
| | 44087* | 12 | 125 | 19,3 | T 70 B | 1,5 |
| | 44088* | 15 | 100 | 24,2 | T 70 B | 1,5 |
| | 44089* | 18 | 83 | 29,8 | T 70 B | 1,5 |
| | 44090* | 24 | 63 | 38,6 | T 70 B | 1,5 |
| | 44091* | 2 X 6 | 2 x 125 | 2 x 9,7 | T 70 B | 1,5 |
| | 44092* | 2 x 9 | 2 x 83 | 2 x 15 | T 70 B | 1,5 |
| | 44093* | 2 x 12 | 2 x 63 | 2 x 19,3 | T 70 B | 1,5 |
| | 44094* | 2 x 15 | 2 x 50 | 2 x 24,2 | T 70 B | 1,5 |
| | 44095** | 2 x 18 | 2 x 42 | 2 x 29 | T 70 B | 1,5 |
| | 44096** | 2 x 24 | 2 x 31 | 2 x 38,6 | T 70 B | 1,5 |

* Items usually available on stock

| | | | | | | |
|---|--------|--------|---------|----------|--------|-----|
|  | 44647 | 6 | 283 | 9,8 | T 50 B | 1,7 |
| | 44648 | 9 | 189 | 14,8 | T 50 B | 1,7 |
| | 44649 | 12 | 142 | 19,7 | T 50 B | 1,7 |
| | 44650 | 15 | 113 | 24,6 | T 50 B | 1,7 |
| | 44651 | 18 | 94 | 30,3 | T 50 B | 1,7 |
| | 44652 | 24 | 71 | 39,3 | T 50 B | 1,7 |
| | 44653 | 2 x 6 | 2 x 142 | 2 x 9,8 | T 50 B | 1,7 |
| | 44654 | 2 x 9 | 2 x 94 | 2 x 15,2 | T 50 B | 1,7 |
| | 44655 | 2 x 12 | 2 x 71 | 2 x 19,7 | T 50 B | 1,7 |
| | 44656 | 2 x 15 | 2 x 57 | 2 x 24,6 | T 50 B | 1,7 |
| | 44483* | 2 x 18 | 2 x 47 | 2 x 29,5 | T 50 B | 1,7 |
| | 44484* | 2 x 24 | 2 x 35 | 2 x 39,3 | T 50 B | 1,7 |

| | | | | | | |
|---|--------|--------|---------|----------|--------|-----|
|  | 44657 | 6 | 300 | 9,8 | T 40 B | 1,8 |
| | 44658 | 9 | 200 | 14,8 | T 40 B | 1,8 |
| | 44659 | 12 | 150 | 19,7 | T 40 B | 1,8 |
| | 44660 | 15 | 120 | 24,6 | T 40 B | 1,8 |
| | 44661 | 18 | 100 | 30,3 | T 40 B | 1,8 |
| | 44662 | 24 | 75 | 39,3 | T 40 B | 1,8 |
| | 44663 | 2 x 6 | 2 x 150 | 2 x 9,8 | T 40 B | 1,8 |
| | 44664 | 2 x 9 | 2 x 100 | 2 x 15,2 | T 40 B | 1,8 |
| | 44665 | 2 x 12 | 2 x 75 | 2 x 19,7 | T 40 B | 1,8 |
| | 44666 | 2 x 15 | 2 x 60 | 2 x 24,6 | T 40 B | 1,8 |
| | 44485* | 2 x 18 | 2 x 50 | 2 x 29,5 | T 40 B | 1,8 |
| | 44486* | 2 x 24 | 2 x 38 | 2 x 39,3 | T 40 B | 1,8 |



PRIMARY VOLTAGE 117 V

| Protection | Reference | Secondary voltage V | Secondary current mA | No-load voltage V | Ambient Temperature °C | Rating VA |
|------------|-----------|---------------------|----------------------|-------------------|------------------------|-----------|
| | 44133 | 6 | 333 | 10,4 | T 70 B | 2 |
| | 44134 | 9 | 222 | 15,5 | T 70 B | 2 |
| | 44135 | 12 | 167 | 20,7 | T 70 B | 2 |
| | 44136 | 15 | 133 | 25,8 | T 70 B | 2 |
| | 44137 | 18 | 111 | 30,8 | T 70 B | 2 |
| | 44138 | 24 | 83 | 41,4 | T 70 B | 2 |
| | 44139 | 2 X 6 | 2 x 167 | 2 x 10,4 | T 70 B | 2 |
| | 44140 | 2 x 9 | 2 x 111 | 2 x 15,4 | T 70 B | 2 |
| | 44141 | 2 x 12 | 2 x 83 | 2 x 20,7 | T 70 B | 2 |
| | 44142 | 2 x 15 | 2 x 67 | 2 x 25,8 | T 70 B | 2 |
| | 44143 | 2 x 18 | 2 x 56 | 2 x 30,8 | T 70 B | 2 |
| | 44144 | 2 x 24 | 2 x 42 | 2 x 41,4 | T 70 B | 2 |



- Vacuum filling
- Two compartments bobbins
- Self-extinguishing plastics UL 94 VO
- Degree of protection IP 00
- 100 grams weight
- Resin class B CEI 85 (20 000 h testing to CEI 126)
- Inherently short-circuits proof
- 30 V model is VDE EN 61558-2-6 certified (production on request)
- Insulation voltage 4 KV

| | | | | | | |
|--|-------|--------|---------|----------|--------|-----|
| | 44750 | 6 | 383 | 10,5 | T 50 B | 2,3 |
| | 44751 | 9 | 256 | 15,5 | T 50 B | 2,3 |
| | 44752 | 12 | 192 | 21 | T 50 B | 2,3 |
| | 44753 | 15 | 153 | 25,3 | T 50 B | 2,3 |
| | 44754 | 18 | 128 | 31 | T 50 B | 2,3 |
| | 44755 | 24 | 96 | 42 | T 50 B | 2,3 |
| | 44756 | 2 x 6 | 2 x 192 | 2 x 10,5 | T 50 B | 2,3 |
| | 44757 | 2 x 9 | 2 x 128 | 2 x 15,5 | T 50 B | 2,3 |
| | 44758 | 2 x 12 | 2 x 96 | 2 x 21 | T 50 B | 2,3 |
| | 44759 | 2 x 15 | 2 x 77 | 2 x 24,5 | T 50 B | 2,3 |
| | 44760 | 2 x 18 | 2 x 64 | 2 x 31 | T 50 B | 2,3 |
| | 44761 | 2 x 24 | 2 x 48 | 2 x 42 | T 50 B | 2,3 |

| | | | | | | |
|--|-------|--------|---------|----------|--------|-----|
| | 44762 | 6 | 400 | 10,5 | T 40 B | 2,4 |
| | 44763 | 9 | 267 | 15,5 | T 40 B | 2,4 |
| | 44764 | 12 | 200 | 21 | T 40 B | 2,4 |
| | 44765 | 15 | 160 | 25,3 | T 40 B | 2,4 |
| | 44766 | 18 | 133 | 31 | T 40 B | 2,4 |
| | 44767 | 24 | 100 | 42 | T 40 B | 2,4 |
| | 44768 | 2 x 6 | 2 x 200 | 2 x 10,5 | T 40 B | 2,4 |
| | 44769 | 2 x 9 | 2 x 133 | 2 x 15,5 | T 40 B | 2,4 |
| | 44770 | 2 x 12 | 2 x 100 | 2 x 21 | T 40 B | 2,4 |
| | 44771 | 2 x 15 | 2 x 80 | 2 x 24,5 | T 40 B | 2,4 |
| | 44772 | 2 x 18 | 2 x 67 | 2 x 31 | T 40 B | 2,4 |
| | 44773 | 2 x 24 | 2 x 50 | 2 x 42 | T 40 B | 2,4 |

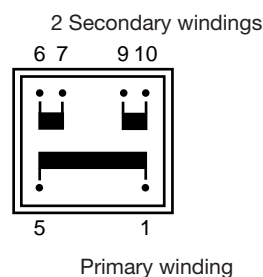
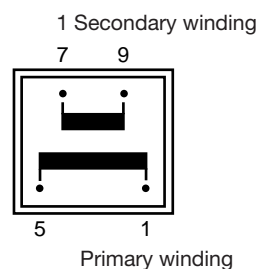

Recommended layout for transformers with 1 secondary winding

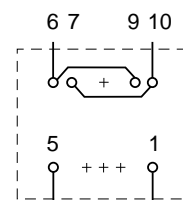

(Allows the use of a transformer with 2 secondary windings)



EN 60950 UL 5085

- 100 % tested production
- Certification : CCA procedure on request

*To be noted : 2 x 18 V and 2 x 24 V models are non-approved.
Those transformers meet all requirement of EN 61558-2-4

| PRIMARY VOLTAGE 230 V | | | | | | |
|--------------------------|-----------|---------------------|----------------------|-------------------|------------------------|-----------|
| Protection | Reference | Secondary voltage V | Secondary current mA | No-load voltage V | Ambient Temperature °C | Rating VA |
| | 44121* | 6 | 333 | 10,4 | T 70 B | 2 |
| | 44122* | 9 | 222 | 15,5 | T 70 B | 2 |
| | 44123* | 12 | 167 | 20,7 | T 70 B | 2 |
| | 44124* | 15 | 133 | 25,8 | T 70 B | 2 |
| | 44125* | 18 | 111 | 30,8 | T 70 B | 2 |
| | 44126* | 24 | 83 | 41,4 | T 70 B | 2 |
| | 44127* | 2 X 6 | 2 x 167 | 2 x 10,4 | T 70 B | 2 |
| | 44128* | 2 x 9 | 2 x 111 | 2 x 15,4 | T 70 B | 2 |
| | 44129* | 2 x 12 | 2 x 83 | 2 x 20,7 | T 70 B | 2 |
| | 44130* | 2 x 15 | 2 x 67 | 2 x 25,8 | T 70 B | 2 |
| | 44131** | 2 x 18 | 2 x 56 | 2 x 30,8 | T 70 B | 2 |
| | 44132** | 2 x 24 | 2 x 42 | 2 x 41,4 | T 70 B | 2 |

*Items usually available on stock

| | | | | | | |
|--|--------|--------|---------|----------|--------|-----|
| | 44667 | 6 | 383 | 10,5 | T 50 B | 2,3 |
| | 44668 | 9 | 256 | 15,5 | T 50 B | 2,3 |
| | 44669 | 12 | 192 | 21 | T 50 B | 2,3 |
| | 44670 | 15 | 153 | 25,3 | T 50 B | 2,3 |
| | 44671 | 18 | 128 | 31 | T 50 B | 2,3 |
| | 44672 | 24 | 96 | 42 | T 50 B | 2,3 |
| | 44673 | 2 x 6 | 2 x 192 | 2 x 10,5 | T 50 B | 2,3 |
| | 44674 | 2 x 9 | 2 x 128 | 2 x 15,5 | T 50 B | 2,3 |
| | 44675 | 2 x 12 | 2 x 96 | 2 x 21 | T 50 B | 2,3 |
| | 44676 | 2 x 15 | 2 x 77 | 2 x 24,5 | T 50 B | 2,3 |
| | 44487* | 2 x 18 | 2 x 64 | 2 x 31 | T 50 B | 2,3 |
| | 44488* | 2 x 24 | 2 x 48 | 2 x 42 | T 50 B | 2,3 |

| | | | | | | |
|--|--------|--------|---------|----------|--------|-----|
| | 44677 | 6 | 400 | 10,5 | T 40 B | 2,4 |
| | 44678 | 9 | 267 | 15,5 | T 40 B | 2,4 |
| | 44679 | 12 | 200 | 21 | T 40 B | 2,4 |
| | 44680 | 15 | 160 | 25,3 | T 40 B | 2,4 |
| | 44681 | 18 | 133 | 31 | T 40 B | 2,4 |
| | 44682 | 24 | 100 | 42 | T 40 B | 2,4 |
| | 44683 | 2 x 6 | 2 x 200 | 2 x 10,5 | T 40 B | 2,4 |
| | 44684 | 2 x 9 | 2 x 133 | 2 x 15,5 | T 40 B | 2,4 |
| | 44685 | 2 x 12 | 2 x 100 | 2 x 21 | T 40 B | 2,4 |
| | 44686 | 2 x 15 | 2 x 80 | 2 x 24,5 | T 40 B | 2,4 |
| | 44489* | 2 x 18 | 2 x 67 | 2 x 31 | T 40 B | 2,4 |
| | 44490* | 2 x 24 | 2 x 50 | 2 x 42 | T 40 B | 2,4 |

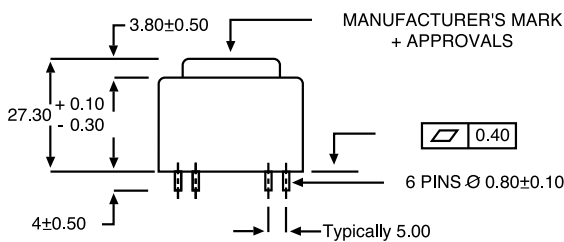
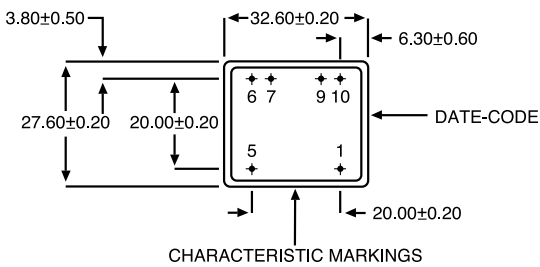

** RECOMMENDED DRILL-HOLE DIAMETER FOR 1.3 mm PINS

ENCAPSULATED TRANSFORMERS
44000 SERIES



PRIMARY VOLTAGE 117 V

| Protection | Reference | Secondary voltage V | Secondary current mA | No-load voltage V | Ambient Temperature °C | Rating VA |
|------------|-----------|---------------------|----------------------|-------------------|------------------------|-----------|
| | 44169 | 6 | 383 | 10,5 | T 70 B | 2,3 |
| | 44170 | 9 | 256 | 15,7 | T 70 B | 2,3 |
| | 44171 | 12 | 192 | 21 | T 70 B | 2,3 |
| | 44172 | 15 | 153 | 25,9 | T 70 B | 2,3 |
| | 44173 | 18 | 128 | 31,4 | T 70 B | 2,3 |
| | 44174 | 24 | 96 | 41,9 | T 70 B | 2,3 |
| | 44175 | 2 X 6 | 2 x 192 | 2 x 10,5 | T 70 B | 2,3 |
| | 44176 | 2 x 9 | 2 x 128 | 2 x 15,7 | T 70 B | 2,3 |
| | 44177 | 2 x 12 | 2 x 96 | 2 x 21 | T 70 B | 2,3 |
| | 44178 | 2 x 15 | 2 x 77 | 2 x 25,9 | T 70 B | 2,3 |
| | 44179 | 2 x 18 | 2 x 64 | 2 x 31,4 | T 70 B | 2,3 |
| | 44180 | 2 x 24 | 2 x 48 | 2 x 41,9 | T 70 B | 2,3 |

| | | | | | | |
|--|-------|--------|---------|----------|--------|-----|
| | 44774 | 6 | 450 | 10,5 | T 50 B | 2,7 |
| | 44775 | 9 | 300 | 15,4 | T 50 B | 2,7 |
| | 44776 | 12 | 225 | 21,1 | T 50 B | 2,7 |
| | 44777 | 15 | 180 | 26,3 | T 50 B | 2,7 |
| | 44778 | 18 | 150 | 30,9 | T 50 B | 2,7 |
| | 44779 | 24 | 113 | 42 | T 50 B | 2,7 |
| | 44780 | 2 x 6 | 2 x 225 | 2 x 10,5 | T 50 B | 2,7 |
| | 44781 | 2 x 9 | 2 x 150 | 2 x 15,4 | T 50 B | 2,7 |
| | 44782 | 2 x 12 | 2 x 113 | 2 x 21,1 | T 50 B | 2,7 |
| | 44783 | 2 x 15 | 2 x 90 | 2 x 26,3 | T 50 B | 2,7 |
| | 44784 | 2 x 18 | 2 x 75 | 2 x 31,5 | T 50 B | 2,7 |
| | 44785 | 2 x 24 | 2 x 56 | 2 x 42,1 | T 50 B | 2,7 |

| | | | | | | |
|--|-------|--------|---------|----------|--------|-----|
| | 44786 | 6 | 467 | 10,5 | T 40 B | 2,8 |
| | 44787 | 9 | 311 | 15,4 | T 40 B | 2,8 |
| | 44788 | 12 | 233 | 21,1 | T 40 B | 2,8 |
| | 44789 | 15 | 187 | 26,3 | T 40 B | 2,8 |
| | 44790 | 18 | 156 | 30,9 | T 40 B | 2,8 |
| | 44791 | 24 | 117 | 42,1 | T 40 B | 2,8 |
| | 44792 | 2 x 6 | 2 x 233 | 2 x 10,5 | T 40 B | 2,8 |
| | 44793 | 2 x 9 | 2 x 156 | 2 x 15,4 | T 40 B | 2,8 |
| | 44794 | 2 x 12 | 2 x 117 | 2 x 21,1 | T 40 B | 2,8 |
| | 44795 | 2 x 15 | 2 x 93 | 2 x 26,3 | T 40 B | 2,8 |
| | 44796 | 2 x 18 | 2 x 77 | 2 x 31,5 | T 40 B | 2,8 |
| | 44797 | 2 x 24 | 2 x 58 | 2 x 42,1 | T 40 B | 2,8 |



- Vacuum filling
- Two compartments bobbins
- Self-extinguishing plastics UL 94 VO
- Degree of protection IP 00
- 70 grams weight
- Resin class B CEI 85 (20 000 h testing to CEI 126)
- Inherently short-circuits proof
- 30 V model is VDE EN 61558-2-6 certified (production on request)

1 Secondary winding

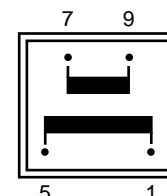

Primary winding

2 Secondary windings

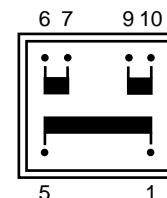

Primary winding

Recommended layout for transformers with 1 secondary winding

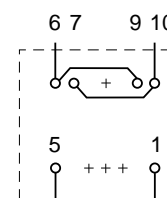

(Allows the use of a transformer with 2 secondary windings)

EN 60950 UL 5085 

- Insulation voltage 4 KV
- 100 % tested production
- Certification : CCA procedure on request

*To be noted : 2 x 18 V and 2 x 24 V models are non-approved.
Those transformers meet all requirement of EN 61558-2-4

PRIMARY VOLTAGE 230 V

| Protection | Reference | Secondary voltage V | Secondary current mA | No-load voltage V | Ambient Temperature °C | Rating VA |
|---|-----------|---------------------|----------------------|-------------------|------------------------|-----------|
|  | 44157* | 6 | 383 | 10,5 | T 70 B | 2,3 |
| | 44158* | 9 | 256 | 15,7 | T 70 B | 2,3 |
| | 44159* | 12 | 192 | 21 | T 70 B | 2,3 |
| | 44160* | 15 | 153 | 25,9 | T 70 B | 2,3 |
| | 44161* | 18 | 128 | 31,4 | T 70 B | 2,3 |
| | 44162* | 24 | 96 | 41,9 | T 70 B | 2,3 |
| | 44163* | 2 X 6 | 2 x 192 | 2 x 10,5 | T 70 B | 2,3 |
| | 44164* | 2 x 9 | 2 x 128 | 2 x 15,7 | T 70 B | 2,3 |
| | 44165* | 2 x 12 | 2 x 96 | 2 x 21 | T 70 B | 2,3 |
| | 44166* | 2 x 15 | 2 x 77 | 2 x 25,9 | T 70 B | 2,3 |
| | 44167** | 2 x 18 | 2 x 64 | 2 x 31,4 | T 70 B | 2,3 |
| | 44168** | 2 x 24 | 2 x 48 | 2 x 41,9 | T 70 B | 2,3 |

*Items usually available on stock

| | | | | | | |
|---|--------|--------|---------|----------|--------|-----|
|  | 44687 | 6 | 450 | 10,5 | T 50 B | 2,7 |
| | 44688 | 9 | 300 | 15,4 | T 50 B | 2,7 |
| | 44689 | 12 | 225 | 21,1 | T 50 B | 2,7 |
| | 44690 | 15 | 180 | 26,3 | T 50 B | 2,7 |
| | 44691 | 18 | 150 | 30,9 | T 50 B | 2,7 |
| | 44692 | 24 | 113 | 42 | T 50 B | 2,7 |
| | 44693 | 2 x 6 | 2 x 225 | 2 x 10,5 | T 50 B | 2,7 |
| | 44694 | 2 x 9 | 2 x 150 | 2 x 15,4 | T 50 B | 2,7 |
| | 44695 | 2 x 12 | 2 x 113 | 2 x 21,1 | T 50 B | 2,7 |
| | 44696 | 2 x 15 | 2 x 90 | 2 x 26,3 | T 50 B | 2,7 |
| | 44491* | 2 x 18 | 2 x 75 | 2 x 31,5 | T 50 B | 2,7 |
| | 44492* | 2 x 24 | 2 x 56 | 2 x 42,1 | T 50 B | 2,7 |

| | | | | | | |
|---|--------|--------|---------|----------|--------|-----|
|  | 44697 | 6 | 467 | 10,5 | T 40 B | 2,8 |
| | 44698 | 9 | 311 | 15,4 | T 40 B | 2,8 |
| | 44699 | 12 | 233 | 21,1 | T 40 B | 2,8 |
| | 44700 | 15 | 187 | 26,3 | T 40 B | 2,8 |
| | 44701 | 18 | 156 | 30,9 | T 40 B | 2,8 |
| | 44702 | 24 | 117 | 42,1 | T 40 B | 2,8 |
| | 44703 | 2 x 6 | 2 x 233 | 2 x 10,5 | T 40 B | 2,8 |
| | 44704 | 2 x 9 | 2 x 156 | 2 x 15,4 | T 40 B | 2,8 |
| | 44705 | 2 x 12 | 2 x 117 | 2 x 21,1 | T 40 B | 2,8 |
| | 44706 | 2 x 15 | 2 x 93 | 2 x 26,3 | T 40 B | 2,8 |
| | 44493* | 2 x 18 | 2 x 70 | 2 x 31,5 | T 40 B | 2,8 |
| | 44494* | 2 x 24 | 2 x 58 | 2 x 42,1 | T 40 B | 2,8 |

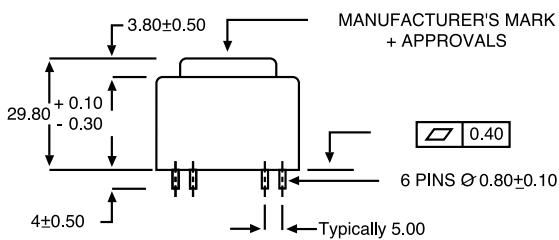
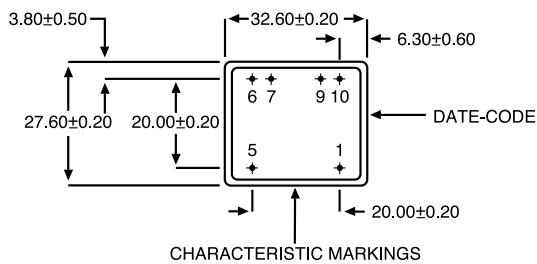

** RECOMMENDED DRILL-HOLE DIAMETER FOR 1.3 mm PINS

ENCAPSULATED TRANSFORMERS
44000 SERIES

**PRIMARY VOLTAGE
117 V**

| Secondary protection mA | Reference | Secondary voltage V | Secondary current mA | No-load voltage V | Ambient Temperature °C | Rating VA |
|-------------------------|-----------|---------------------|----------------------|-------------------|------------------------|-----------|
| 630 | 44205 | 6 | 533 | 8 | T 70 B | 3,2 |
| 400 | 44206 | 9 | 356 | 12 | T 70 B | 3,2 |
| 315 | 44207 | 12 | 267 | 16 | T 70 B | 3,2 |
| 250 | 44208 | 15 | 213 | 20 | T 70 B | 3,2 |
| 200 | 44209 | 18 | 178 | 24,1 | T 70 B | 3,2 |
| 160 | 44210 | 24 | 133 | 32,1 | T 70 B | 3,2 |
| 315 | 44211 | 2 x 6 | 2 x 267 | 2 x 8 | T 70 B | 3,2 |
| 200 | 44212 | 2 x 9 | 2 x 178 | 2 x 12 | T 70 B | 3,2 |
| 160 | 44213 | 2 x 12 | 2 x 133 | 2 x 16 | T 70 B | 3,2 |
| 125 | 44214 | 2 x 15 | 2 x 107 | 2 x 20 | T 70 B | 3,2 |
| 100 | 44215 | 2 x 18 | 2 x 89 | 2 x 24 | T 70 B | 3,2 |
| 80 | 44216 | 2 x 24 | 2 x 67 | 2 x 32,1 | T 70 B | 3,2 |



EN 61558-2-6

- Vacuum filling
- Two compartments bobbins
- Self-extinguishing plastics UL 94 V0
- Degree of protection IP 00
- 150 grams weight
- Resin class B CEI 85 (20 000 h testing to CEI 126)
- Fuse protection on secondary side (see diagram) to be assumed by customer

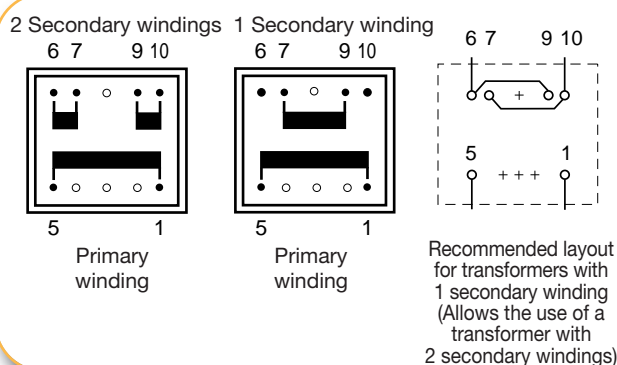
**PRIMARY VOLTAGE
117 V**

| Secondary protection mA | Reference | Secondary voltage V | Secondary current mA | No-load voltage V | Ambient Temperature °C | Rating VA |
|-------------------------|-----------|---------------------|----------------------|-------------------|------------------------|-----------|
| 800 | 44241 | 6 | 833 | 8,4 | T 50 B | 5 |
| 630 | 44242 | 9 | 556 | 12,6 | T 50 B | 5 |
| 400 | 44243 | 12 | 417 | 16,9 | T 50 B | 5 |
| 315 | 44244 | 15 | 333 | 21 | T 50 B | 5 |
| 315 | 44245 | 18 | 278 | 25,3 | T 50 B | 5 |
| 200 | 44246 | 24 | 208 | 33,7 | T 50 B | 5 |
| 400 | 44247 | 2 x 6 | 2 x 417 | 2 x 8,4 | T 50 B | 5 |
| 315 | 44248 | 2 x 9 | 2 x 278 | 2 x 12,6 | T 50 B | 5 |
| 200 | 44249 | 2 x 12 | 2 x 208 | 2 x 16,9 | T 50 B | 5 |
| 160 | 44250 | 2 x 15 | 2 x 167 | 2 x 21 | T 50 B | 5 |
| 160 | 44251 | 2 x 18 | 2 x 139 | 2 x 25,3 | T 50 B | 5 |
| 100 | 44252 | 2 x 24 | 2 x 104 | 2 x 33,7 | T 50 B | 5 |



EN 61558-2-6

- Vacuum filling
- Two compartments bobbins
- Self-extinguishing plastics UL 94 V0
- Degree of protection IP 00
- 200 grams weight
- Resin class B CEI 85 (20 000 h testing to CEI 126)
- Fuse protection on secondary side (see diagram) to be assumed by customer

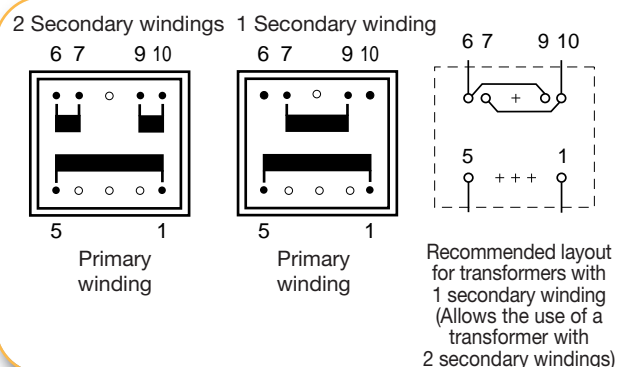

3,2 VA

EI 38-13,6

SERIE 44000

EN 60950 UL 5085 

- 30 V and 36 V models are VDE EN 61558-2-6 certified (production on request)
- Insulation voltage 4 KV
- 100 % tested production
- Certification : CCA procedure on request

*To be noted : 2 x 24 V model is non-approved.
Those transformers meet all requirement of EN 61558-2-4

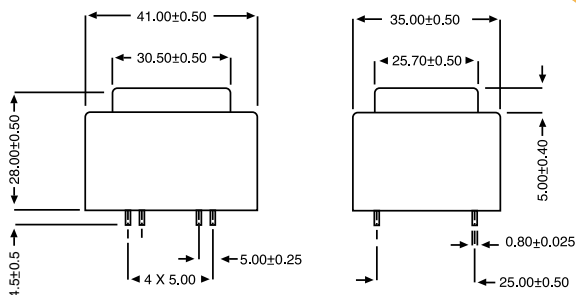

** RECOMMENDED DRILL-HOLE DIAMETER FOR 1,3 mm PINS

PRIMARY VOLTAGE 230 V

| Secondary protection mA | Reference | Secondary voltage V | Secondary current mA | No-load voltage V | Ambient Temperature °C | Rating VA |
|-------------------------|-----------|---------------------|----------------------|-------------------|------------------------|-----------|
| 630 | 44193 | 6 | 533 | 8 | T 70 B | 3,2 |
| 400 | 44194 | 9 | 356 | 12 | T 70 B | 3,2 |
| 315 | 44195 | 12 | 267 | 16 | T 70 B | 3,2 |
| 250 | 44196 | 15 | 213 | 20 | T 70 B | 3,2 |
| 200 | 44197 | 18 | 178 | 24,1 | T 70 B | 3,2 |
| 160 | 44198 | 24 | 133 | 32,1 | T 70 B | 3,2 |
| 315 | 44199 | 2 x 6 | 2 x 267 | 2 x 8 | T 70 B | 3,2 |
| 200 | 44200 | 2 x 9 | 2 x 178 | 2 x 12 | T 70 B | 3,2 |
| 160 | 44201 | 2 x 12 | 2 x 133 | 2 x 16 | T 70 B | 3,2 |
| 125 | 44202 | 2 x 15 | 2 x 107 | 2 x 20 | T 70 B | 3,2 |
| 100 | 44203 | 2 x 18 | 2 x 89 | 2 x 24 | T 70 B | 3,2 |
| 80 | 44204* | 2 x 24 | 2 x 67 | 2 x 32,1 | T 70 B | 3,2 |

5 VA

EI 42-14,8

SERIE 44000

EN 60950 UL 5085 

- 30 V and 36 V models are VDE EN 61558-2-6 certified (production on request)
- Insulation voltage 4 KV
- 100 % tested production
- Certification : CCA procedure on request

*To be noted : 2 x 24 V model is non-approved.
Those transformers meet all requirement of EN 61558-2-4

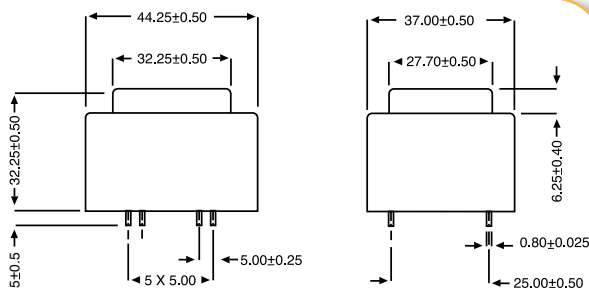

** RECOMMENDED DRILL-HOLE DIAMETER FOR 1,3 mm PINS

PRIMARY VOLTAGE 230 V

| Secondary protection mA | Reference | Secondary voltage V | Secondary current mA | No-load voltage V | Ambient Temperature °C | Rating VA |
|-------------------------|-----------|---------------------|----------------------|-------------------|------------------------|-----------|
| 800 | 44229 | 6 | 833 | 8,4 | T 50 B | 5 |
| 630 | 44230 | 9 | 556 | 12,6 | T 50 B | 5 |
| 400 | 44231 | 12 | 417 | 16,9 | T 50 B | 5 |
| 315 | 44232 | 15 | 333 | 21 | T 50 B | 5 |
| 315 | 44233 | 18 | 278 | 25,3 | T 50 B | 5 |
| 200 | 44234 | 24 | 208 | 33,7 | T 50 B | 5 |
| 400 | 44235 | 2 x 6 | 2 x 417 | 2 x 8,4 | T 50 B | 5 |
| 315 | 44236 | 2 x 9 | 2 x 278 | 2 x 12,6 | T 50 B | 5 |
| 200 | 44237 | 2 x 12 | 2 x 208 | 2 x 16,9 | T 50 B | 5 |
| 160 | 44238 | 2 x 15 | 2 x 167 | 2 x 21 | T 50 B | 5 |
| 160 | 44239 | 2 x 18 | 2 x 139 | 2 x 25,3 | T 50 B | 5 |
| 100 | 44240* | 2 x 24 | 2 x 104 | 2 x 33,7 | T 50 B | 5 |

ENCAPSULATED TRANSFORMERS
44000 SERIES



PRIMARY VOLTAGE 117 V

| Primary protection mA | Reference | Secondary voltage V | Secondary current mA | No-load voltage V | Ambient Temperature °C | Rating VA |
|-----------------------|-----------|---------------------|----------------------|-------------------|------------------------|-----------|
| 125 | 44277 | 6 | 1667 | 7,2 | T 50 B | 10 |
| 125 | 44278 | 9 | 1111 | 10,8 | T 50 B | 10 |
| 125 | 44279 | 12 | 833 | 14,4 | T 50 B | 10 |
| 125 | 44280 | 15 | 667 | 18,1 | T 50 B | 10 |
| 125 | 44281 | 18 | 556 | 21,6 | T 50 B | 10 |
| 125 | 44282 | 24 | 417 | 28,9 | T 50 B | 10 |
| 125 | 44283 | 2 x 6 | 2 x 833 | 2 x 7,2 | T 50 B | 10 |
| 125 | 44284 | 2 x 9 | 2 x 556 | 2 x 10,8 | T 50 B | 10 |
| 125 | 44285 | 2 x 12 | 2 x 417 | 2 x 14,4 | T 50 B | 10 |
| 125 | 44286 | 2 x 15 | 2 x 333 | 2 x 18,1 | T 50 B | 10 |
| 125 | 44287 | 2 x 18 | 2 x 278 | 2 x 21,6 | T 50 B | 10 |
| 125 | 44288 | 2 x 24 | 2 x 208 | 2 x 28,9 | T 50 B | 10 |



EN 61558-2-6

- Vacuum filling
- Two compartments bobbins
- Self-extinguishing plastics UL 94 V0
- Degree of protection IP 00
- 300 grams weight
- Resin class B CEI 85 (20 000 h testing to CEI 126)
- Fuse protection on primary side (see diagram) to be assumed by customer

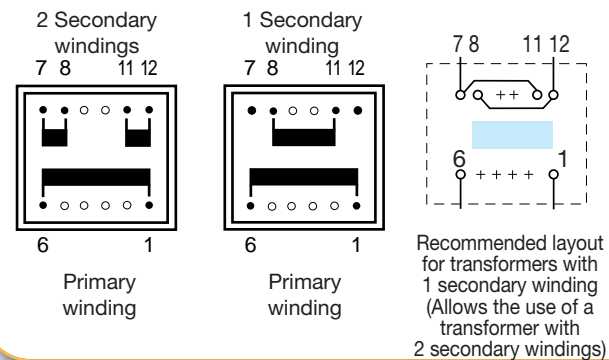

PRIMARY VOLTAGE 117 V

| Secondary protection mA | Reference | Secondary voltage V | Secondary current mA | No-load voltage V | Ambient Temperature °C | Rating VA |
|-------------------------|-----------|---------------------|----------------------|-------------------|------------------------|-----------|
| 2,5 | 44313 | 6 | 2667 | 7,4 | T 50 B | 16 |
| 2,0 | 44314 | 9 | 1778 | 11,1 | T 50 B | 16 |
| 1,25 | 44315 | 12 | 1333 | 14,7 | T 50 B | 16 |
| 1 | 44316 | 15 | 1067 | 18,4 | T 50 B | 16 |
| 1 | 44317 | 18 | 889 | 22,1 | T 50 B | 16 |
| 0,63 | 44318 | 24 | 667 | 29,3 | T 50 B | 16 |
| 1,25 | 44319 | 2 x 6 | 2 x 1333 | 2 x 7,4 | T 50 B | 16 |
| 1 | 44320 | 2 x 9 | 2 x 889 | 2 x 11,1 | T 50 B | 16 |
| 0,63 | 44321 | 2 x 12 | 2 x 667 | 2 x 14,7 | T 50 B | 16 |
| 0,5 | 44322 | 2 x 15 | 2 x 533 | 2 x 18,4 | T 50 B | 16 |
| 0,5 | 44323 | 2 x 18 | 2 x 444 | 2 x 22 | T 50 B | 16 |
| 0,315 | 44324 | 2 x 24 | 2 x 333 | 2 x 29,3 | T 50 B | 16 |



EN 61558-2-6

- Vacuum filling
- Two compartments bobbins
- Self-extinguishing plastics UL 94 V0
- Degree of protection IP 00
- 400 grams weight
- Resin class B CEI 85 (20 000 h testing to CEI 126)
- Fuse protection on secondary side (see diagram) to be assumed by customer

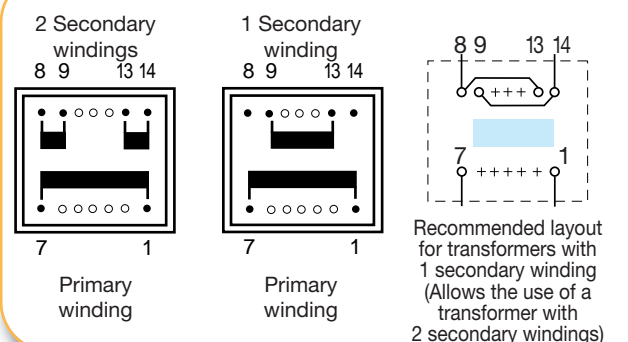



EN 60950 UL 5085 

- 30 V and 36 V models are VDE EN 61558-2-6 certified (production on request)
- Insulation voltage 4 KV
- 100 % tested production
- Certification : CCA procedure on request

*To be noted : 2 x 24 V model is non-approved.
Those transformers meet all requirement of EN 61558-2-4

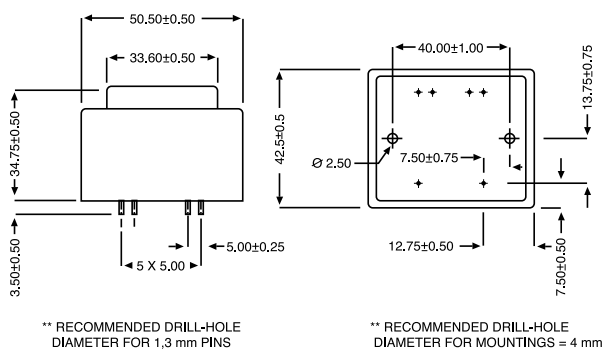

PRIMARY VOLTAGE 230 V

| Primary protection mA | Reference | Secondary voltage V | Secondary current mA | No-load voltage V | Ambient Temperature °C | Rating VA |
|-----------------------|-----------|---------------------|----------------------|-------------------|------------------------|-----------|
| 63 | 44265 | 6 | 1667 | 7,2 | T 50 B | 10 |
| 63 | 44266 | 9 | 1111 | 10,8 | T 50 B | 10 |
| 63 | 44267 | 12 | 833 | 14,4 | T 50 B | 10 |
| 63 | 44268 | 15 | 667 | 18,1 | T 50 B | 10 |
| 63 | 44269 | 18 | 556 | 21,6 | T 50 B | 10 |
| 63 | 44270 | 24 | 417 | 28,9 | T 50 B | 10 |
| 63 | 44271 | 2 x 6 | 2 x 833 | 2 x 7,2 | T 50 B | 10 |
| 63 | 44272 | 2 x 9 | 2 x 556 | 2 x 10,8 | T 50 B | 10 |
| 63 | 44273 | 2 x 12 | 2 x 417 | 2 x 14,4 | T 50 B | 10 |
| 63 | 44274 | 2 x 15 | 2 x 333 | 2 x 18,1 | T 50 B | 10 |
| 63 | 44275 | 2 x 18 | 2 x 278 | 2 x 21,6 | T 50 B | 10 |
| 63 | 44276* | 2 x 24 | 2 x 208 | 2 x 28,9 | T 50 B | 10 |



EN 60950 UL 5085 

- 30 V and 36 V models are VDE EN 61558-2-6 certified (production on request)
- Insulation voltage 4 KV
- 100 % tested production
- Certification : CCA procedure on request

*To be noted : 2 x 24 V model is non-approved.
Those transformers meet all requirement of EN 61558-2-4

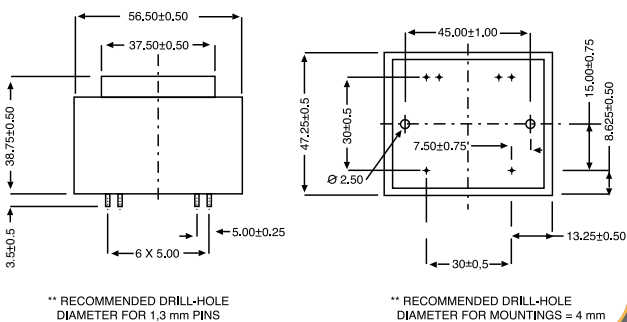

PRIMARY VOLTAGE 230 V

| Secondary protection mA | Reference | Secondary voltage V | Secondary current mA | No-load voltage V | Ambient Temperature °C | Rating VA |
|-------------------------|-----------|---------------------|----------------------|-------------------|------------------------|-----------|
| 2,500 | 44301 | 6 | 2667 | 7,4 | T 50 B | 16 |
| 2,000 | 44302 | 9 | 1778 | 11,1 | T 50 B | 16 |
| 1,25 | 44303 | 12 | 1333 | 14,7 | T 50 B | 16 |
| 1 | 44304 | 15 | 1067 | 18,4 | T 50 B | 16 |
| 1 | 44305 | 18 | 889 | 22,1 | T 50 B | 16 |
| 0,63 | 44306 | 24 | 667 | 29,3 | T 50 B | 16 |
| 1,25 | 44307 | 2 x 6 | 2 x 1333 | 2 x 7,4 | T 50 B | 16 |
| 1 | 44308 | 2 x 9 | 2 x 889 | 2 x 11,1 | T 50 B | 16 |
| 0,63 | 44309 | 2 x 12 | 2 x 667 | 2 x 14,7 | T 50 B | 16 |
| 0,5 | 44310 | 2 x 15 | 2 x 533 | 2 x 18,4 | T 50 B | 16 |
| 0,5 | 44311 | 2 x 18 | 2 x 444 | 2 x 22 | T 50 B | 16 |
| 0,315 | 44312* | 2 x 24 | 2 x 333 | 2 x 29,3 | T 50 B | 16 |

ENCAPSULATED TRANSFORMERS
44000 SERIES



PRIMARY VOLTAGE 117 V

| Primary protection mA | Reference | Secondary voltage V | Secondary current mA | No-load voltage V | Ambient Temperature °C | Rating VA |
|-----------------------|-----------|---------------------|----------------------|-------------------|------------------------|-----------|
| 250 | 44444 | 6 | 3667 | 6,8 | T 50 B | 22 |
| 250 | 44445 | 9 | 2444 | 10,3 | T 50 B | 22 |
| 250 | 44446 | 12 | 1833 | 13,7 | T 50 B | 22 |
| 250 | 44447 | 15 | 1467 | 17,1 | T 50 B | 22 |
| 250 | 44448 | 18 | 1222 | 20,5 | T 50 B | 22 |
| 250 | 44449 | 24 | 917 | 27,3 | T 50 B | 22 |
| 250 | 44450 | 2 x 6 | 2 x 1833 | 2 x 6,8 | T 50 B | 22 |
| 250 | 44451 | 2 x 9 | 2 x 1222 | 2 x 10,3 | T 50 B | 22 |
| 250 | 44452 | 2 x 12 | 2 x 917 | 2 x 13,7 | T 50 B | 22 |
| 250 | 44453 | 2 x 15 | 2 x 733 | 2 x 17,1 | T 50 B | 22 |
| 250 | 44454 | 2 x 18 | 2 x 611 | 2 x 20,5 | T 50 B | 22 |
| 250 | 44455 | 2 x 24 | 2 x 458 | 2 x 27,3 | T 50 B | 22 |

EN 61558-2-6

- Vacuum filling
- Two compartments bobbins
- Self-extinguishing plastics UL 94 V0
- Degree of protection IP 00
- 550 grams weight
- Resin class B CEI 85 (20 000 h testing to CEI 126)
- Fuse protection on primary side (see diagram) to be assumed by customer

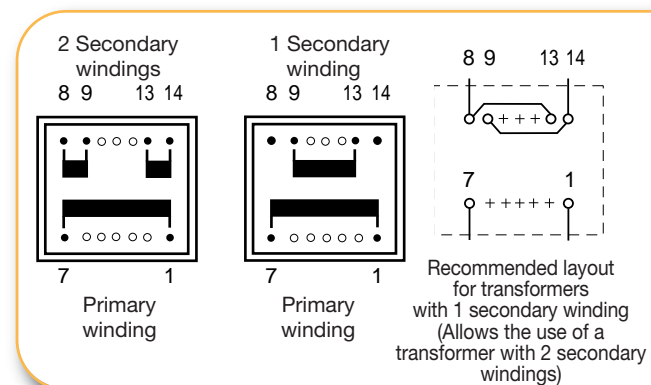

PRIMARY VOLTAGE 117 V

| Primary protection mA | Reference | Secondary voltage V | Secondary current mA | No-load voltage V | Ambient Temperature °C | Rating VA |
|-----------------------|-----------|---------------------|----------------------|-------------------|------------------------|-----------|
| 315 | 44385 | 6 | 5000 | 6,9 | T 50 B | 30 |
| 315 | 44386 | 9 | 3333 | 10,3 | T 50 B | 30 |
| 315 | 44387 | 12 | 2500 | 13,8 | T 50 B | 30 |
| 315 | 44388 | 15 | 2000 | 17,2 | T 50 B | 30 |
| 315 | 44389 | 18 | 1667 | 20,8 | T 50 B | 30 |
| 315 | 44390 | 24 | 1250 | 27,7 | T 50 B | 30 |
| 315 | 44391 | 2 x 6 | 2 x 2500 | 2 x 6,9 | T 50 B | 30 |
| 315 | 44392 | 2 x 9 | 2 x 1667 | 2 x 10,3 | T 50 B | 30 |
| 315 | 44393 | 2 x 12 | 2 x 1250 | 2 x 13,8 | T 50 B | 30 |
| 315 | 44394 | 2 x 15 | 2 x 1000 | 2 x 17,2 | T 50 B | 30 |
| 315 | 44395 | 2 x 18 | 2 x 833 | 2 x 20,8 | T 50 B | 30 |
| 315 | 44396 | 2 x 24 | 2 x 625 | 2 x 27,7 | T 50 B | 30 |

EN 61558-2-6

- Vacuum filling
- Two compartments bobbins
- Self-extinguishing plastics UL 94 V0
- Degree of protection IP 00
- 700 grams weight
- Resin class B CEI 85 (20 000 h testing to CEI 126)
- Fuse protection on primary side (see diagram) to be assumed by customer

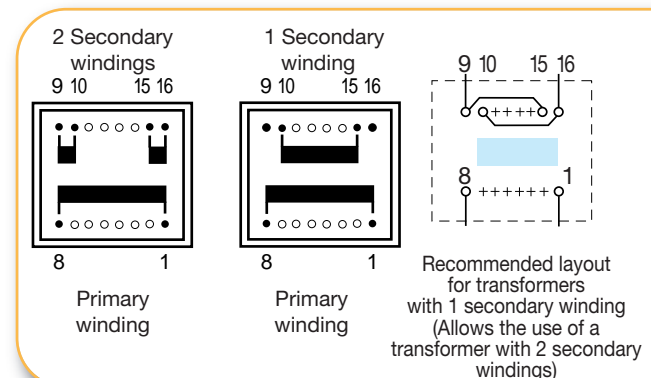

EN 60950 UL 5085 

- 30 V and 36 V models are VDE EN 61558-2-6 certified (production on request)
- Insulation voltage 4 KV
- 100 % tested production
- Certification : CCA procedure on request

*To be noted : 2 x 24 V model is non-approved.
Those transformers meet all requirement of EN 61558-2-4

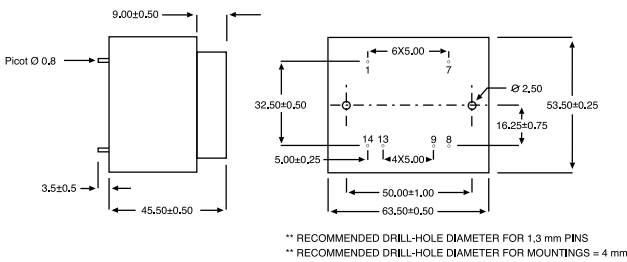

PRIMARY VOLTAGE 230 V

| Primary protection mA | Reference | Secondary voltage V | Secondary current mA | No-load voltage V | Ambient Temperature °C | Rating VA |
|-----------------------|-----------|---------------------|----------------------|-------------------|------------------------|-----------|
| 125 | 44432 | 6 | 3667 | 6,8 | T 50 B | 22 |
| 125 | 44433 | 9 | 2444 | 10,3 | T 50 B | 22 |
| 125 | 44434 | 12 | 1833 | 13,7 | T 50 B | 22 |
| 125 | 44435 | 15 | 1467 | 17,1 | T 50 B | 22 |
| 125 | 44436 | 18 | 1222 | 20,5 | T 50 B | 22 |
| 125 | 44437 | 24 | 917 | 27,3 | T 50 B | 22 |
| 125 | 44438 | 2 x 6 | 2 x 1833 | 2 x 6,8 | T 50 B | 22 |
| 125 | 44439 | 2 x 9 | 2 x 1222 | 2 x 10,3 | T 50 B | 22 |
| 125 | 44440 | 2 x 12 | 2 x 917 | 2 x 13,7 | T 50 B | 22 |
| 125 | 44441 | 2 x 15 | 2 x 733 | 2 x 17,1 | T 50 B | 22 |
| 125 | 44442 | 2 x 18 | 2 x 611 | 2 x 20,5 | T 50 B | 22 |
| 125 | 44443* | 2 x 24 | 2 x 458 | 2 x 27,3 | T 50 B | 22 |

EN 60950 UL 5085 

- 30 V and 36 V models are VDE EN 61558-2-6 certified (production on request)
- Insulation voltage 4 KV
- 100 % tested production
- Certification : CCA procedure on request

*To be noted : 2 x 24 V model is non-approved.
Those transformers meet all requirement of EN 61558-2-4

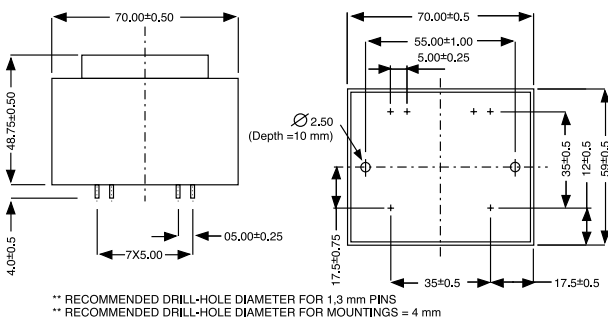

PRIMARY VOLTAGE 230 V

| Primary protection mA | Reference | Secondary voltage V | Secondary current mA | No-load voltage V | Ambient Temperature °C | Rating VA |
|-----------------------|-----------|---------------------|----------------------|-------------------|------------------------|-----------|
| 160 | 44373 | 6 | 5000 | 6,9 | T 50 B | 30 |
| 160 | 44374 | 9 | 3333 | 10,3 | T 50 B | 30 |
| 160 | 44375 | 12 | 2500 | 13,8 | T 50 B | 30 |
| 160 | 44376 | 15 | 2000 | 17,2 | T 50 B | 30 |
| 160 | 44377 | 18 | 1667 | 20,8 | T 50 B | 30 |
| 160 | 44378 | 24 | 1250 | 27,7 | T 50 B | 30 |
| 160 | 44379 | 2 x 6 | 2 x 2500 | 2 x 6,9 | T 50 B | 30 |
| 160 | 44380 | 2 x 9 | 2 x 1667 | 2 x 10,3 | T 50 B | 30 |
| 160 | 44381 | 2 x 12 | 2 x 1250 | 2 x 13,8 | T 50 B | 30 |
| 160 | 44382 | 2 x 15 | 2 x 1000 | 2 x 17,2 | T 50 B | 30 |
| 160 | 44383 | 2 x 18 | 2 x 833 | 2 x 20,8 | T 50 B | 30 |
| 160 | 44384* | 2 x 24 | 2 x 625 | 2 x 27,7 | T 50 B | 30 |

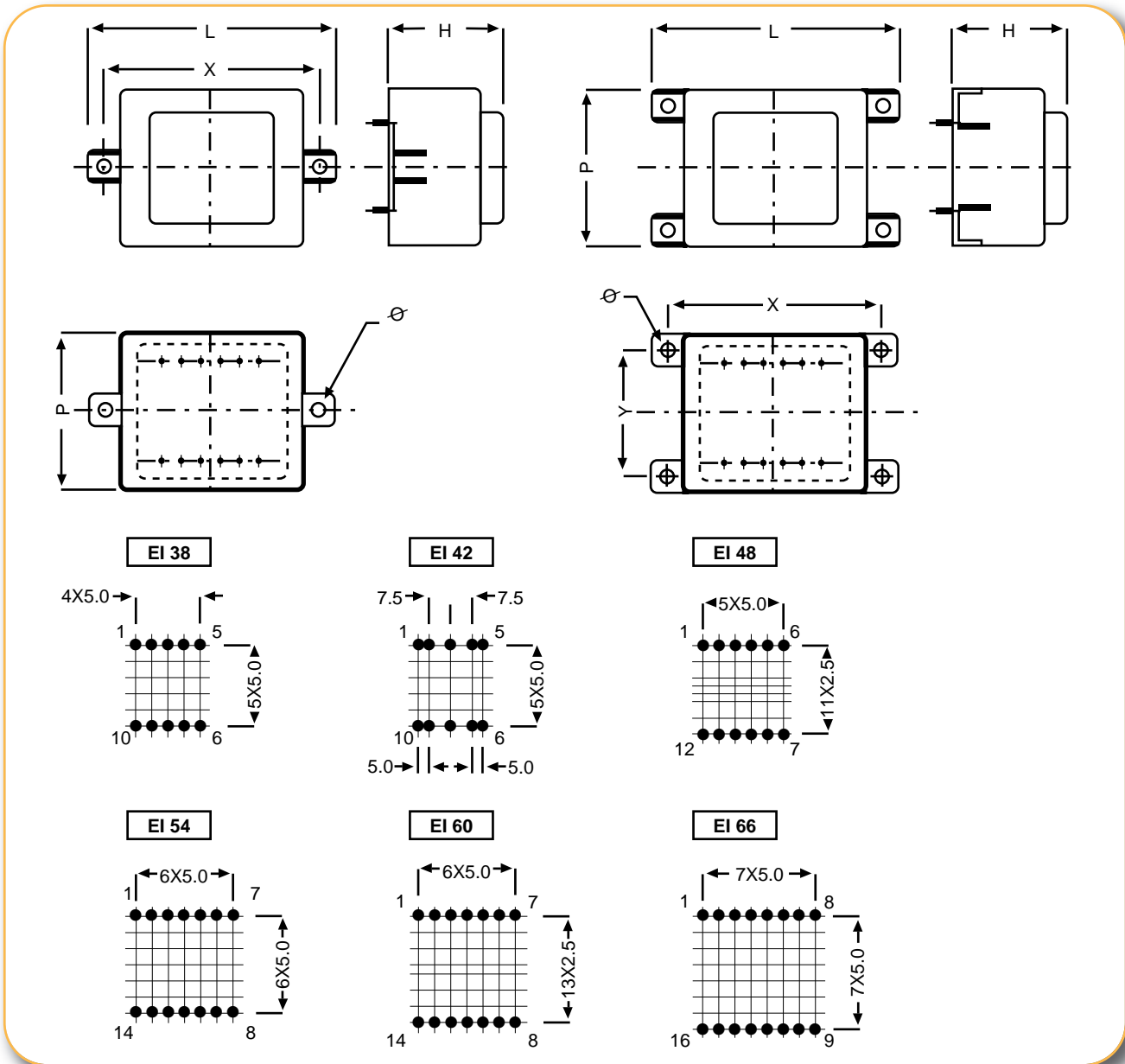

| CIRCUIT | L ± 0,50 | P ± 0,40 | H ± 0,40 | X ± 0,50 | Y ± 0,50 | Ø ± 0,3 |
|--------------|-------------|-------------|-------------|-------------|-------------|------------|
| EI 38 X 13,6 | 55,6 | 34,9 | 28,1 | 47,5 | | 3,2 |
| EI 42 X 14,8 | 64 | 37 | 32,3 | 55,0 | | 4,2 |
| EI 48 X 16,8 | 69 | 42,3 | 34,6 | 60 | | 4,2 |
| EI 54 X 18,8 | 74 | 47,3 | 38,8 | 65 | | 4,2 |
| EI 60 X 21 | 81,5 | 53,3 | 44,7 | 72,5 | 43,5 | 4,2 |
| EI 66 X 23 | 87,2 | 58,6 | 48,5 | 77,5 | 47,5 | 4,2 |

Series 44000 transformers can be equipped with boxes with lugs and also 2,8 «faston» terminal tags while still conforming to the specifications in the standard references.

- For boxes with 2 lugs and pin type output, add suffix 1 to the reference of the standard transformer (example : 44198-1)
- For boxes with 2 lugs and 2,8 «faston» output, add suffix 2 to the reference of the standard transformer (example : 44199-2)
- For boxes with 4 lugs and pin type output, add suffix 3 to the reference of the standard transformer (example : 44200-3)
- For boxes with 4 lugs and 2,8 «faston» output, add suffix 4 to the reference of the standard transformer (example : 44201-4)

These models are not available on stock.

- 1 VA** • 230 V supply voltage by series/parallel connection
- Vacuum filling
- One compartment housing **1 VA**
- Two compartments bobbins 0,8 VA
- Degree of protection IP 00
- 50 grams weight

- Resin UL 94 V0
- Design protection against short-circuits
- Insulation voltage 4 KV
- 100 % tested production

Conform to EN 61558 - UL 5085

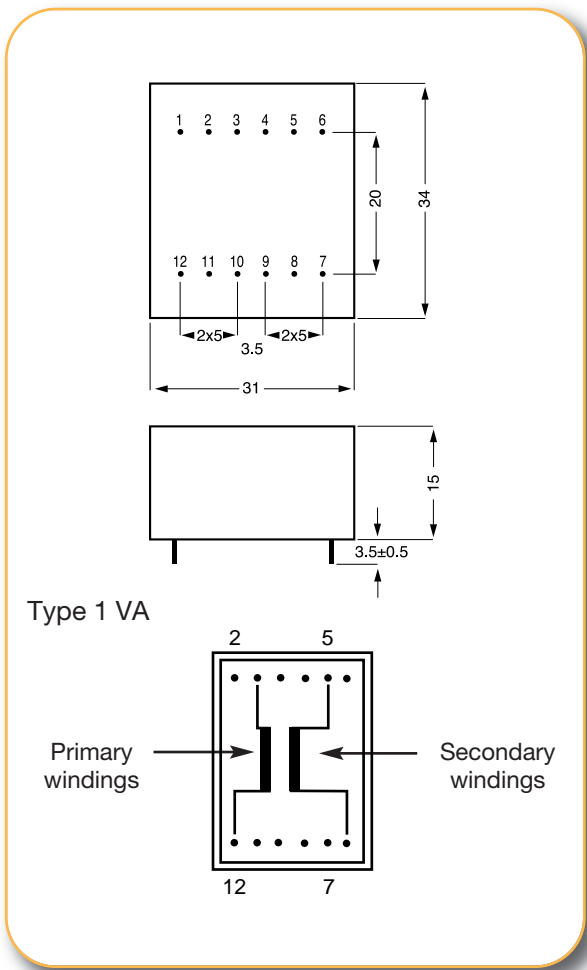

| PRIMARY VOLTAGE 230 V | | | | | |
|---|-----------|---------------------|----------------------|-------------------|------------------------|
| Protection | Reference | Secondary voltage V | Secondary current mA | No-load voltage V | Ambient Temperature °C |
| UI 21 | | 230 V | | 1 VA | |
|  | 45001 | 6 | 167 | 11,4 | T 70 B |
| | 45002 | 9 | 111 | 17 | T 70 B |
| | 45003 | 12 | 83 | 22,8 | T 70 B |
| | 45004 | 15 | 67 | 28,5 | T 70 B |
| | 45005 | 18 | 56 | 34,2 | T 70 B |
| | 45006 | 24 | 42 | 45,6 | T 70 B |

QUALITY IN SERIES



PRIMARY VOLTAGE 115 V - 230 V

| Protection | Reference | Secondary voltage V | Secondary current mA | No-load voltage V | Ambient Temperature °C |
|---------------------|-----------|--------------------------------|----------------------|-------------------|------------------------|
| UI 30 x 5,5 | | 2 VA | | | |
| | 45292 | 2 x 6 | 2 x 167 | 2 x 10,2 | T 70 B |
| | 45293 | 2 x 9 | 2 x 111 | 2 x 15,9 | T 70 B |
| | 45294 | 2 x 12 | 2 x 83 | 2 x 20,4 | T 70 B |
| | 45295 | 2 x 15 | 2 x 67 | 2 x 25,5 | T 70 B |
| | 45296 | 2 x 18 | 2 x 56 | 2 x 30,6 | T 70 B |
| | 45297 | 2 x 24 | 2 x 42 | 2 x 40,8 | T 70 B |
| UI 30 x 5,5 | | Secondary protection mA | | 3 VA | |
| 250 | 45013 | 2 x 6 | 2 x 250 | 2 x 9,8 | T 70 B |
| 160 | 45014 | 2 x 9 | 2 x 167 | 2 x 14,7 | T 70 B |
| 125 | 45015 | 2 x 12 | 2 x 125 | 2 x 19,6 | T 70 B |
| 100 | 45016 | 2 x 15 | 2 x 100 | 2 x 24,5 | T 70 B |
| 80 | 45017 | 2 x 18 | 2 x 83 | 2 x 29,5 | T 70 B |
| 63 | 45018 | 2 x 24 | 2 x 63 | 2 x 39,3 | T 70 B |
| UI 30 x 7,5 | | Secondary protection mA | | 4 VA | |
| 315 | 45019 | 2 x 6 | 2 x 333 | 2 x 9,4 | T 70 B |
| 250 | 45020 | 2 x 9 | 2 x 222 | 2 x 14,0 | T 70 B |
| 160 | 45021 | 2 x 12 | 2 x 167 | 2 x 18,6 | T 70 B |
| 125 | 45022 | 2 x 15 | 2 x 133 | 2 x 23,3 | T 70 B |
| 125 | 45023 | 2 x 18 | 2 x 111 | 2 x 28,0 | T 70 B |
| 80 | 45024 | 2 x 24 | 2 x 83 | 2 x 37,4 | T 70 B |
| UI 30 x 10,5 | | Secondary protection mA | | 6 VA | |
| 500 | 45025 | 2 x 6 | 2 x 500 | 2 x 8,1 | T 70 B |
| 315 | 45026 | 2 x 9 | 2 x 333 | 2 x 12,1 | T 70 B |
| 250 | 45027 | 2 x 12 | 2 x 250 | 2 x 16,2 | T 70 B |
| 200 | 45028 | 2 x 15 | 2 x 200 | 2 x 20,2 | T 70 B |
| 160 | 45029 | 2 x 18 | 2 x 167 | 2 x 24,3 | T 70 B |
| 125 | 45030 | 2 x 24 | 2 x 125 | 2 x 32,3 | T 70 B |
| UI 30 x 16,5 | | Primary protection mA | | 10 VA | |
| 125/63 | 45031 | 2 x 6 | 2 x 833 | 2 x 7,9 | T 50 B |
| 125/63 | 45032 | 2 x 9 | 2 x 556 | 2 x 11,9 | T 50 B |
| 125/63 | 45033 | 2 x 12 | 2 x 417 | 2 x 15,9 | T 50 B |
| 125/63 | 45034 | 2 x 15 | 2 x 333 | 2 x 19,8 | T 50 B |
| 125/63 | 45035 | 2 x 18 | 2 x 278 | 2 x 23,7 | T 50 B |
| 125/63 | 45036 | 2 x 24 | 2 x 208 | 2 x 31,7 | T 50 B |

- 115 V- 230 V supply voltage by series/parallel connection
- Vacuum filling
- Two compartments bobbins
- Degree of protection IP 00
- Resin class UL 94 V0

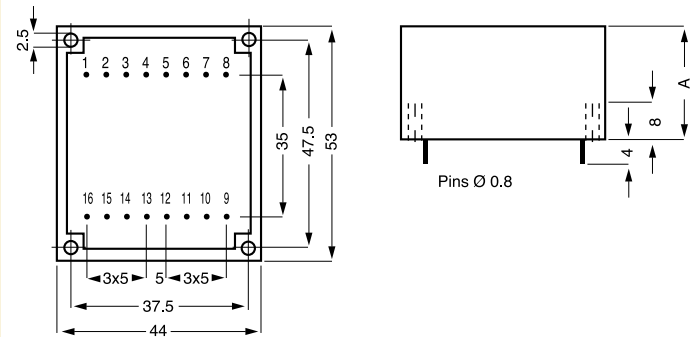

| CIRCUIT | RATING | DIMENSION A | WEIGHT |
|--------------|-----------|-------------|--------|
| UI 30 x 5,5 | 2 VA/3 VA | A = 17 mm | 125 g |
| UI 30 x 7,5 | 4 VA | A = 19 mm | 150 g |
| UI 30 x 10,5 | 6 VA | A = 22 mm | 185 g |
| UI 30 x 16,5 | 10 VA | A = 28 mm | 260 g |

Possible primary connections

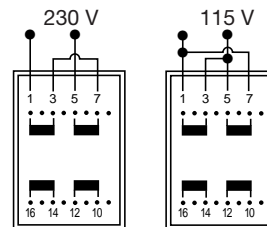

Possible secondary connections

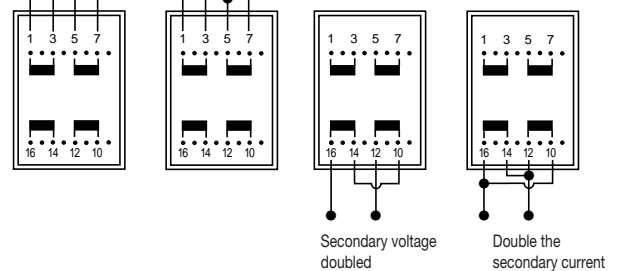

QUALITY IN SERIES



EN 60950 UL 5085 

- Fuse protection in secondary winding (see diagram)
- Insulation voltage 4 KV
- 100 % tested production
- Conform to EN 61558
Approval under process
- UL 5085 approved

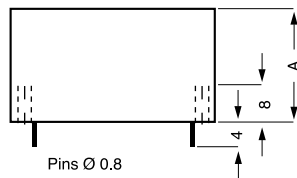
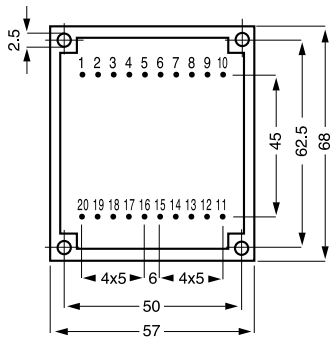

| CIRCUIT | RATING | DIMENSION A | WEIGHT |
|--------------|--------|-------------|--------|
| UI 39 x 8 | 10 VA | A = 22 mm | 285 g |
| UI 39 x 10,2 | 14 VA | A = 24 mm | 335 g |
| UI 39 x 13,5 | 18 VA | A = 27 mm | 405 g |
| UI 39 x 17 | 24 VA | A = 31 mm | 480 g |
| UI 39 x 21 | 30 VA | A = 35 mm | 550 g |

Possible primary connections

Possible secondary connections

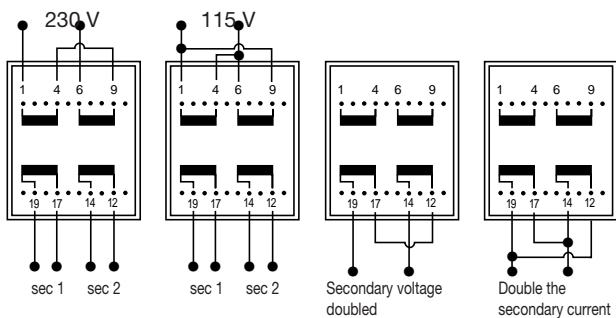

PRIMARY VOLTAGE 115 V - 230 V

| Primary protection 115 V/230 V mA | Reference | Secondary voltage V | Secondary current mA | No-load voltage V | Ambient Temperature °C |
|---|-----------|------------------------|-------------------------|----------------------|---------------------------|
| UI 39 x 8 | | 10 VA | | | |
| 125/63 | 45037 | 2 x 6 | 2 x 833 | 2 x 8,2 | T 50 B |
| 125/63 | 45038 | 2 x 9 | 2 x 555 | 2 x 12,3 | T 50 B |
| 125/63 | 45039 | 2 x 12 | 2 x 416 | 2 x 16,4 | T 50 B |
| 125/63 | 45040 | 2 x 15 | 2 x 333 | 2 x 20,5 | T 50 B |
| 125/63 | 45041 | 2 x 18 | 2 x 277 | 2 x 24,6 | T 50 B |
| 125/63 | 45042 | 2 x 24 | 2 x 208 | 2 x 32,8 | T 50 B |
| UI 39 x 10,2 | | 14 VA | | | |
| 160/80 | 45043 | 2 x 6 | 2 x 1167 | 2 x 7,5 | T 50 B |
| 160/80 | 45044 | 2 x 9 | 2 x 778 | 2 x 10,9 | T 50 B |
| 160/80 | 45045 | 2 x 12 | 2 x 583 | 2 x 15,0 | T 50 B |
| 160/80 | 45046 | 2 x 15 | 2 x 467 | 2 x 18,7 | T 50 B |
| 160/80 | 45047 | 2 x 18 | 2 x 389 | 2 x 22,4 | T 50 B |
| 160/80 | 45048 | 2 x 24 | 2 x 292 | 2 x 30,2 | T 50 B |
| UI 39 x 13,5 | | 18 VA | | | |
| 200/100 | 45049 | 2 x 6 | 2 x 1500 | 2 x 7,4 | T 50 B |
| 200/100 | 45050 | 2 x 9 | 2 x 1000 | 2 x 11,0 | T 50 B |
| 200/100 | 45051 | 2 x 12 | 2 x 750 | 2 x 14,7 | T 50 B |
| 200/100 | 45052 | 2 x 15 | 2 x 600 | 2 x 18,3 | T 50 B |
| 200/100 | 45053 | 2 x 18 | 2 x 500 | 2 x 22,0 | T 50 B |
| 200/100 | 45054 | 2 x 24 | 2 x 375 | 2 x 29,4 | T 50 B |
| UI 39 x 17 | | 24 VA | | | |
| 250/125 | 45055 | 2 x 6 | 2 x 2000 | 2 x 7,1 | T 50 B |
| 250/125 | 45056 | 2 x 9 | 2 x 1333 | 2 x 10,6 | T 50 B |
| 250/125 | 45057 | 2 x 12 | 2 x 1000 | 2 x 14,1 | T 50 B |
| 250/125 | 45058 | 2 x 15 | 2 x 800 | 2 x 17,6 | T 50 B |
| 250/125 | 45059 | 2 x 18 | 2 x 667 | 2 x 21,2 | T 50 B |
| 250/125 | 45060 | 2 x 24 | 2 x 500 | 2 x 28,3 | T 50 B |
| UI 39 x 21 | | 30 VA | | | |
| 315/160 | 45061 | 2 x 6 | 2 x 2500 | 2 x 6,7 | T 50 B |
| 315/160 | 45062 | 2 x 9 | 2 x 1667 | 2 x 10,15 | T 50 B |
| 315/160 | 45063 | 2 x 12 | 2 x 1250 | 2 x 13,5 | T 50 B |
| 315/160 | 45064 | 2 x 15 | 2 x 1000 | 2 x 16,8 | T 50 B |
| 315/160 | 45065 | 2 x 18 | 2 x 833 | 2 x 20,2 | T 50 B |
| 315/160 | 45066 | 2 x 24 | 2 x 625 | 2 x 27,0 | T 50 B |

ENCAPSULATED TRANSFORMERS

45000 SERIES



- 115 V- 230 V supply voltage by series/parallel connection
- Vacuum filling
- Two compartments bobbins
- Degree of protection IP 00
- Resin class UL 94 V0

- Fuse protection in secondary winding (see diagram)
- Insulation voltage 4 KV
- 100 % tested production
- Conform to EN 61558 Approval under process
- UL 5085 approved

| PRIMARY VOLTAGE 115 V - 230 V | | | | | |
|---------------------------------------|-----------|------------------------|-------------------------|----------------------|---------------------------|
| Primary protection 115/230 V mA | Reference | Secondary voltage V | Secondary current mA | No-load voltage V | Ambient Temperature °C |
| UI 48 x 17 | | | 40 VA | | |
| 400/200 | 45067 | 2 x 6 | 2 x 3333 | 2 x 6,7 | T 50 B |
| 400/200 | 45068 | 2 x 9 | 2 x 2222 | 2 x 10,0 | T 50 B |
| 400/200 | 45069 | 2 x 12 | 2 x 1667 | 2 x 13,4 | T 50 B |
| 400/200 | 45070 | 2 x 15 | 2 x 1333 | 2 x 16,7 | T 50 B |
| 400/200 | 45071 | 2 x 18 | 2 x 1111 | 2 x 20,1 | T 50 B |
| 400/200 | 45072 | 2 x 24 | 2 x 833 | 2 x 26,8 | T 50 B |
| UI 48 x 26 | | | 60 VA | | |
| 630/315 | 45073 | 2 x 6 | 2 x 5000 | 2 x 6,6 | T 50 B |
| 630/315 | 45074 | 2 x 9 | 2 x 3333 | 2 x 9,9 | T 50 B |
| 630/315 | 45075 | 2 x 12 | 2 x 2500 | 2 x 13,1 | T 50 B |
| 630/315 | 45076 | 2 x 15 | 2 x 2000 | 2 x 16,4 | T 50 B |
| 630/315 | 45077 | 2 x 18 | 2 x 1667 | 2 x 19,7 | T 50 B |
| 630/315 | 45078 | 2 x 24 | 2 x 1250 | 2 x 26,3 | T 50 B |

| CIRCUIT | RATING | A | B | C | WEIGHT |
|------------|--------|------|------|----|--------|
| UI 48 x 17 | 40 VA | 38,5 | 13,5 | 83 | 760 g |
| UI 48 x 26 | 60 VA | 48,5 | 14,5 | 86 | 1060 g |

Pins 0,5 x 1,2

Possible primary connections: 230 V and 115 V

Possible secondary connections: Secondary voltage doubled and Double the secondary current

ENCAPSULATED TRANSFORMERS
45000 SERIES

QUALITY IN SERIES



SIDE-MOUNTING TRANSFORMERS

• FLF / FLC SERIES

- Primary voltage : 230 V 50/60 Hz
- Secondary voltage : 12 V ou 24 V
- Maximum ambient temperature : + 40 °C
- Insulation class : B
- Insulation voltage : 4 kV
- Standards applicable : VDE 0570 - EN 61558 - UL 5085
- Degree of protection IP 00

- Prepared for protection class II

- Options : 00 Standard

01 Addition of a thermal fuse
(non-resettable)

02 Addition of a resettable thermal
protection system

- On request : all primary and secondary voltages up to 500 V (consult us for details)

• FLF SERIES : connection by UL-approved flexible

cables (600 V/105°C)

AWG 18 up to 6 A

AWG 16 up to 10 A

AWG 14 up to 20 A

standard length :
250 mm

• FLC SERIES : connection by «faston» connectors

Rating

primary

secondary

3,2 VA-5 VA

2,8 x 0,8

4,8 x 0,8

10 VA-22 VA

4,8 x 0,8

4,8 x 0,8

30 VA-240 VA

6,3 x 0,8

6,3 x 0,8

FLF SERIES

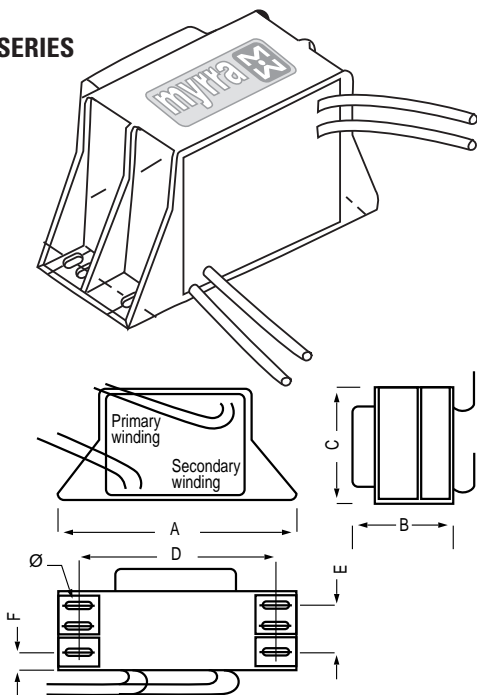

FLC SERIES

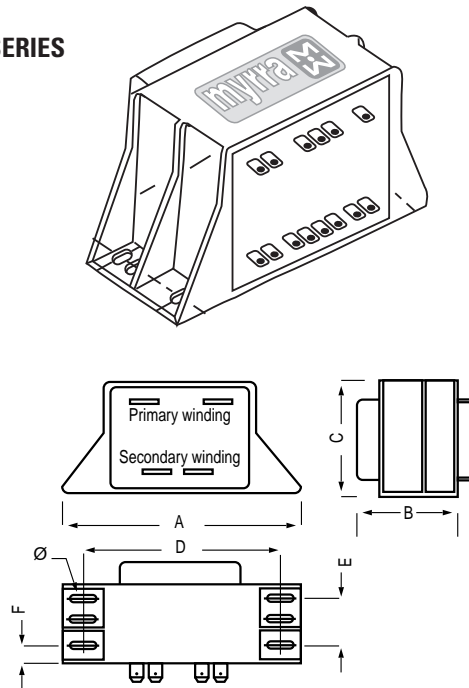

| Rating in VA | References | | | | Drop % | Vs-c % | Effic. % | Fuse | Format | A | B | C | D | E | F | Ø |
|-----------------|------------|-------|-------|-------|-----------|-----------|-------------|--------|--------------|-------|------|------|-------|------|------|-----|
| | FLF | | FLC | | | | | | | | | | | | | |
| | 12 V | 24 V | 12 V | 24 V | | | | | | | | | | | | |
| 3,2 | 30081 | 30094 | 30107 | 30120 | 30 | 28 | 61 | 32 mA | EI 38 x 13,6 | 61 | 33 | 35 | 51 | - | 19,5 | 3,5 |
| 5 | 30082 | 30095 | 30108 | 30121 | 32 | 30 | 62 | 32 mA | EI 42 x 14,8 | 65 | 33 | 38 | 55 | - | 17,8 | 3,5 |
| 10 | 30083 | 30096 | 30109 | 30122 | 25 | 25 | 69 | 63 mA | EI 48 x 16,8 | 75 | 39 | 43 | 62 | 12 | 9 | 3,5 |
| 16 | 30084 | 30097 | 30110 | 30123 | 24 | 23 | 71,5 | 80 mA | EI 54 x 18,4 | 82,5 | 43 | 48,5 | 68 | 11 | 11 | 3,5 |
| 22 | 30085 | 30098 | 30111 | 30124 | 19 | 19 | 76,5 | 125 mA | EI 60 x 21 | 88 | 48 | 53,5 | 75 | 13,5 | 12,2 | 4,8 |
| 30 | 30086 | 30099 | 30112 | 30125 | 16 | 16 | 79,5 | 160 mA | EI 66 x 23 | 94 | 49,5 | 58,5 | 82 | 13 | 13,3 | 4,8 |
| 45 | 30087 | 30100 | 30113 | 30126 | 11 | 11 | 83 | 250 mA | EI 66 x 34,7 | 94 | 61 | 58,5 | 82 | 37,5 | 7,4 | 4,8 |
| 63 | 30088 | 30101 | 30114 | 30127 | 12 | 13 | 83,5 | 315 mA | EI 78 x 27,5 | 112,5 | 59 | 71,5 | 97,5 | 32,5 | 7,6 | 5,2 |
| 100 | 30089 | 30102 | 30115 | 30128 | 13,5 | 15 | 84,5 | 500 mA | EI 84 x 29,5 | 120 | 64 | 75 | 102,5 | 32,5 | 10,2 | 5,5 |
| 160* | 30090 | 30103 | 30116 | 30129 | 12 | 13,5 | 86 | 800 mA | EI 84 x 43,5 | 120 | 78 | 75 | 102,5 | 45 | 10,8 | 5,5 |
| 160 | 30091 | 30104 | 30117 | 30130 | 9,5 | 12 | 88,5 | 800 mA | EI 96 x 35,7 | 133 | 75 | 85 | 115 | 40 | 10,6 | 5,5 |
| 185 | 30092 | 30105 | 30118 | 30131 | 7,8 | 9,8 | 90 | 1,0 A | EI 96 x 45,7 | 133 | 85 | 85 | 115 | 50 | 10,6 | 5,2 |
| 240 | 30093 | 30106 | 30119 | 30132 | 6,4 | 8 | 91 | 1,25 A | EI 96 x 59,7 | 133 | 98,5 | 85 | 115 | 64 | 10,2 | 5,5 |

* Transformer not complying with the standard (for this, it must be equipped with a thermal fuse system)



| MYRRA Part N° | CORE SIZE | Max. Output Power | Outputs | | | | |
|---------------|-----------|-------------------|---------------------|-----|-----|-----|-----|
| | | Watts | Vdc nominal voltage | | | | |
| 74000 | E16 | 5w | 5v | 12v | | | |
| 74001 | E16 | 6w | 5v | | | | |
| 74002 | E16 | 6w | 12v | | | | |
| 74003 | E16 | 5w | 3.3v | 5v | | | |
| 74010 | E16 | 12w | 5v | 12v | | | |
| 74014 | E16 | 12w | 24v | 24v | | | |
| 74015 | E16 | 12w | 5v | 15v | 24v | | |
| 74020 | EL19 | 18w | 5v | 12v | | | |
| 74021 | EL19 | 18w | 5v | 12v | | | |
| 74023 | EL19 | 16w | 3.3v | 5v | 12v | 18v | 30v |
| 74030 | E25 | 30w | 5v | 12v | 12v | | |
| 74032 | E25 | 35w | 24v | | | | |
| 74040 | ETD29 | 60w | 5v | 12v | 5v | 12v | |
| 74043 | ERL28 | 60w | 3.3v | 5v | 12v | 18v | 30v |
| 74050 | ETD34 | 90w | 5v | 12v | 5v | 12v | |
| 74060 | ETD39 | 140w | 5v | 12v | 5v | 12v | |
| 74070 | ETD44 | 180w | 5v | 12v | 5v | 12v | |
| 74080 | EF20 | 24w | 12v | 12v | | | |
| 74081 | EF20 | 20w | 3.3v | 5v | 12v | | |
| 74082 | EF20 | 20w | 5v | 5v | | | |
| 74090 | E16 | 1.5w | 5v | | | | |
| 74091 | E16 | 1.5w | 12v | | | | |
| 74092 | E16 | 3.1w | 5v | | | | |
| 74093 | E16 | 3.1w | 12v | | | | |
| 74094 | E16 | 9w | 5v | | | | |
| 74095 | E16 | 9w | 12v | | | | |

Note : "5 volts" outputs can generally be used for 3.3 to 6volts; "12 volts" outputs can be used for 9 to 16volts. See detailed characteristics.

HIGH FREQUENCY FERRITE
POWER FERRITE TRANSFORMERS



| Transformer Reference | | IC Manufacturer | Series & References |
|--|-----------------|-----------------|-----------------------------|
| 74090 74091 74092 74093 74094 74095 | No aux. Winding | PI | TNY Series LNK XT Series |

| | | | |
|---|-------------------|-----------|---|
| 74000 74001 74002 74003 74004 74005 74010 74014 74015 74020 74021 74023 74080 74081 74082 74087 74088 74089 74030 74032 74040 74043 74050 74060 74070 | With aux. Winding | ONSEMI | NCP 1014 NCP 3065 etc. |
| | | PI | TOP Series LNK Series |
| | | NXP | TEA1530 TEA1351 TEA3065 etc. |
| | | ST | Viper Series |
| | | FAIRCHILD | FAN102 FAN400 FSEZ130 FSEZ1213 etc. |
| | | ON Bright | OB2535 OB2212 OB2361 etc. |

HIGH FREQUENCY FERRITE
POWER FERRITE TRANSFORMERS



- Primary / Secondary Insulation $\geq 4000V$
- Creepage distance Primary / Secondary $\geq 6mm$
- Ambient temperature $< 85^{\circ}C$
- Construction conforms to IEC950, IEC335, IEC61558-2-16 for reinforced insulation
- Exclusively uses UL94-V0 listed materials

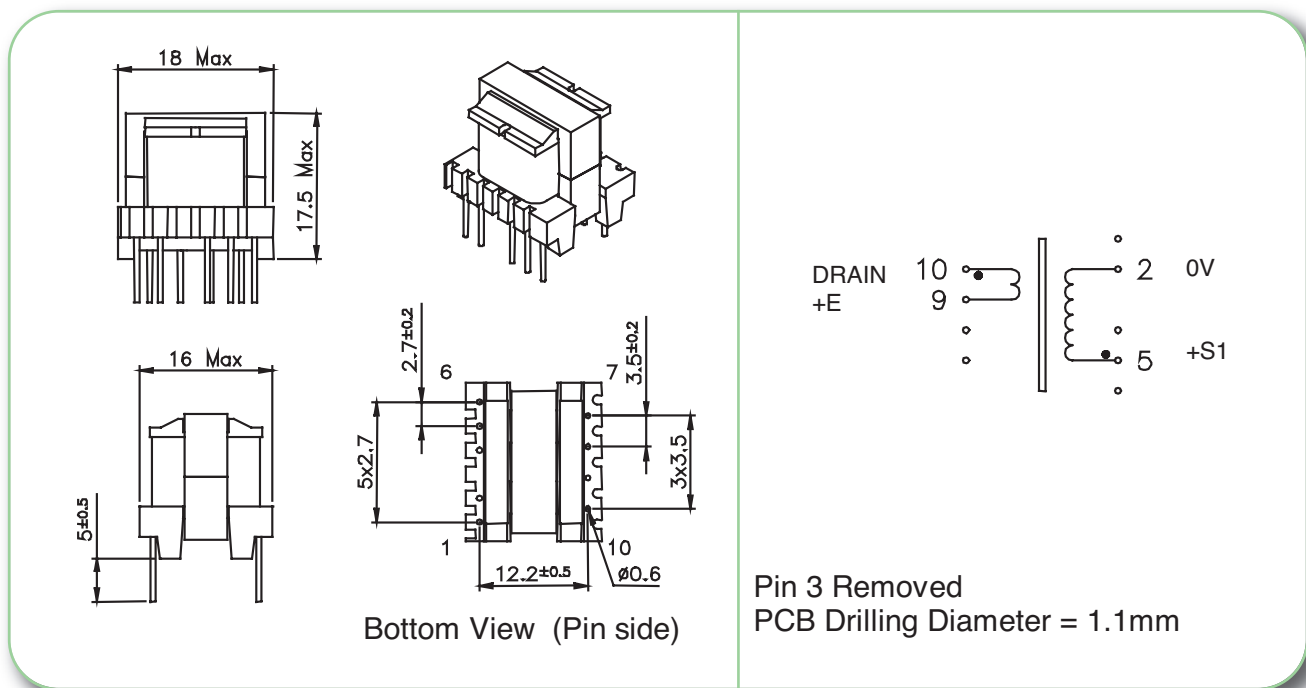

| MYRRA P / N | Output Power maximum | Windings | | | | | |
|--------------|----------------------|----------|--------|-------|--------------|-----------------|---------------------|
| | | | Pins | Turns | Voltage | Current maximum | Inductance (+/-10%) |
| 74090 | 1.5 w | Pri | 10 – 9 | 228 | 85 - 265Vrms | 0.28 Apeak | 6000µH |
| | | S1 | 5 – 2 | 16 | 3.3 – 6 Vdc | 0.4 Adc | |
| 74091 | 1.5 w | Pri | 10 – 9 | 228 | 85 - 265Vrms | 0.28 Apeak | 6000µH |
| | | S1 | 5 – 2 | 28 | 7.5 – 15 Vdc | 0.2 Adc | |

Examples of application with Integrated Circuits :

| MYRRA P / N | Control IC Manufacturer | Input voltage | Power | Frequency |
|--------------|-------------------------|---------------|-------|-----------|
| 74090 | Power Integrations | 85 - 265Vrms | 1.5w | 44kHz |
| 74091 | Power Integrations | 85 - 265Vrms | 1.5w | 44kHz |

HIGH FREQUENCY FERRITE POWER FERRITE TRANSFORMERS



- Primary / Secondary Insulation $\geq 4000V$
- Creepage distance Primary / Secondary $\geq 6mm$
- Ambient temperature $< 70^{\circ}C$
- Construction conforms to IEC950, IEC335, IEC61558-2-16 for reinforced insulation
- Exclusively uses UL94-V0 listed materials

18 Max
17.5 Max
16 Max
5±0.5
2.7±0.2
6
7
3.5±0.2
3x3.5
1
12.2±0.5
Ø0.6
10
9
2 0V
5 +S1

Bottom View (Pin side)

Pin 3 Removed
PCB Drilling Diameter = 1.1mm

| MYRRA P / N | Output Power maximum | Windings | | | | | |
|-------------|----------------------|----------|--------|-------|--------------|-----------------|---------------------|
| | | | Pins | Turns | Voltage | Current maximum | Inductance (+/-10%) |
| 74092 | 3.1 w | Pri | 10 – 9 | 191 | 85 - 265Vrms | 0.34 Apeak | 4200µH |
| | | S1 | 5 – 2 | 13 | 3.3 – 6 Vdc | 0.9 Adc | |
| 74093 | 3.1 w | Pri | 10 – 9 | 191 | 85 - 265Vrms | 0.34 Apeak | 4200µH |
| | | S1 | 5 – 2 | 24 | 7.5 – 15 Vdc | 0.4 Adc | |

Examples of application with Integrated Circuits :

| MYRRA P / N | Control IC Manufacturer | Input voltage | Power | Frequency |
|-------------|-------------------------|---------------|-------|-----------|
| 74092 | Power Integrations | 85 - 265Vrms | 3.1w | 44kHz |
| 74093 | Power Integrations | 85 - 265Vrms | 3.1w | 44kHz |

HIGH FREQUENCY FERRITE
POWER FERRITE TRANSFORMERS



- Primary / Secondary Insulation $\geq 4000V$
- Creepage distance Primary / Secondary $\geq 6mm$
- Ambient temperature $< 60^{\circ}C$
- Construction conforms to IEC950, IEC335, IEC61558-2-16 for reinforced insulation
- Exclusively uses UL94-V0 listed materials

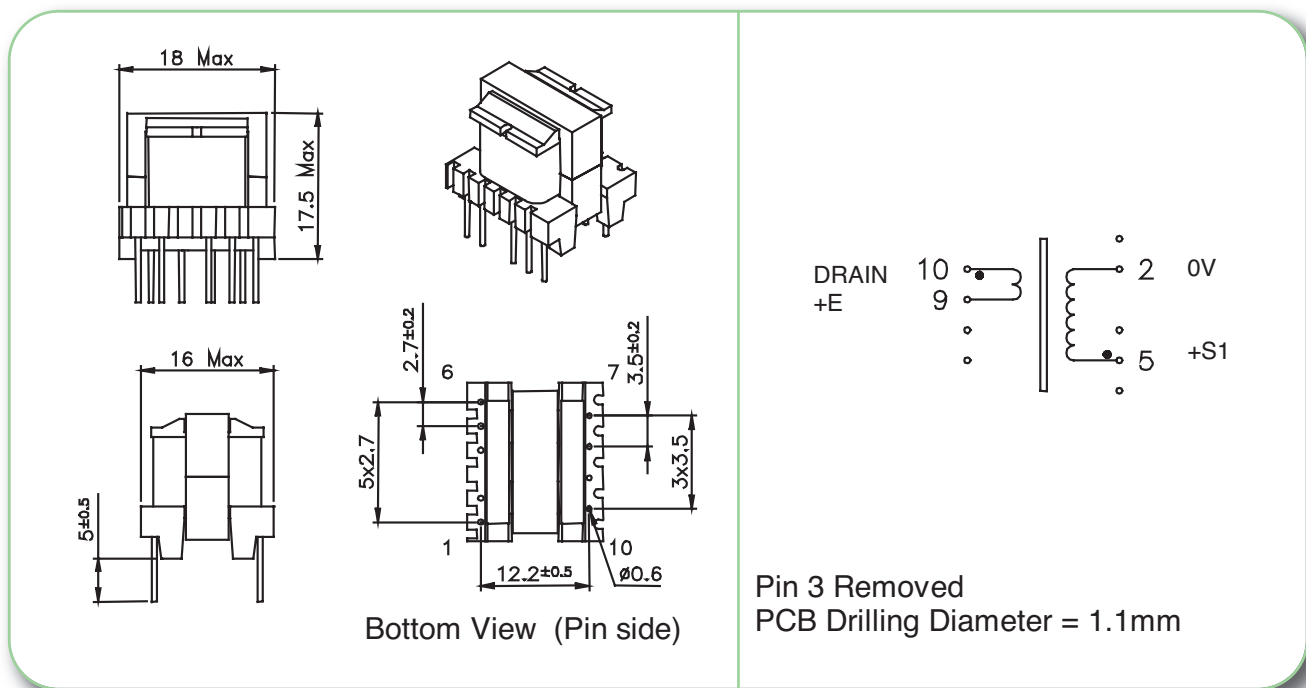

| MYRRA P / N | Output Power maximum | Windings | | | | | |
|-------------|----------------------|----------|--------|-------|--------------|-----------------|---------------------|
| | | | Pins | Turns | Voltage | Current maximum | Inductance (+/-10%) |
| 74094 | 9 w | Pri | 10 – 9 | 135 | 85 - 265Vrms | 0.48 Apeak | 2100µH |
| | | S1 | 5 – 2 | 9 | 3.3 – 6 Vdc | 1.5 Adc | |
| 74095 | 9 w | Pri | 10 – 9 | 135 | 85 - 265Vrms | 0.48 Apeak | 2100µH |
| | | S1 | 5 – 2 | 17 | 7.5 – 15 Vdc | 0.9 Adc | |

Examples of application with Integrated Circuits :

| MYRRA P / N | Control IC Manufacturer | Input voltage | Power | Frequency |
|-------------|-------------------------|---------------|-------|-----------|
| 74094 | Power Integrations | 85 - 265Vrms | 4.2w | 44kHz |
| | Power Integrations | 85 - 265Vrms | 5w | 132kHz |
| | Power Integrations | 85 - 265Vrms | 9w | 132kHz |
| 74095 | Power Integrations | 85 - 265Vrms | 5w | 44kHz |
| | Power Integrations | 85 - 265Vrms | 5w | 132kHz |
| | Power Integrations | 85 - 265Vrms | 9w | 132kHz |

HIGH FREQUENCY FERRITE POWER FERRITE TRANSFORMERS



- Primary / Secondary Insulation $\geq 4000V$
- Primary / Auxiliary Insulation $\geq 1500V$
- Creepage distance Primary / Secondary $\geq 6mm$
- Ambient temperature $< 70^{\circ}C$
- Construction conforms to IEC950, IEC335, IEC61558-2-16 for reinforced insulation
- Exclusively uses UL94-V0 listed materials

Bottom View (Pin side)

74000

PIN 3 Removed
PCB Drilling Diameter = 1.1mm

| MYRRA P / N | Output Power maximum | Windings | | | | | |
|-------------|----------------------|----------|--------|-------|--------------|-----------------|---------------------|
| | | | Pins | Turns | Voltage | Current maximum | Inductance (+/-10%) |
| 74000 | 5 w | Pri | 4 - 6 | 138 | 85 - 265Vrms | 0.27 Apeak | 3900µH |
| | | Aux | 2 - 1 | 16 | 7 – 14 Vdc | 0.1 Adc | |
| | | S1 | 9 - 10 | 8 | 3.3 – 7 Vdc | 1.2 Adc | |
| | | S2 | 7 - 8 | 19 | 8 – 17 Vdc | 0.4 Adc | |

Examples of application with Integrated Circuits :

| MYRRA P / N | Control IC Manufacturer | Input voltage | Power | Frequency |
|-------------|-------------------------|---------------|-------|-----------|
| 74000 | Power Integrations | 85 - 265Vrms | 5w | 132kHz |
| | ST Microelectronics | 85 - 265Vrms | 4w | 70kHz |

HIGH FREQUENCY FERRITE
POWER FERRITE TRANSFORMERS



- Primary / Secondary Insulation $\geq 4000V$
- Primary / Auxiliary Insulation $\geq 1500V$
- Creepage distance Primary / Secondary $\geq 6mm$
- Ambient temperature $< 60^{\circ}C$
- Construction conforms to IEC950, IEC335, IEC61558-2-16 for reinforced insulation
- Exclusively uses UL94-V0 listed materials

Bottom View (Pin side)

PIN 3 Removed
PCB Drilling Diameter = 1.1mm

| MYRRA P / N | Output Power maximum | Windings | | | | | |
|-------------|----------------------|----------|--------|-------|--------------|-----------------|---------------------|
| | | | Pins | Turns | Voltage | Current maximum | Inductance (+/-10%) |
| 74001 | 6 w | Pri | 4 - 6 | 138 | 85 - 265Vrms | 0.35 Apeak | 3000µH |
| | | Aux | 2 - 1 | 20 | 8 - 16 Vdc | 0.1 Adc | |
| | | S1 | 9 - 10 | 8 | 3 - 6 Vdc | 1.2 Adc | |
| 74002 | 6 w | Pri | 4 - 6 | 150 | 85 - 265Vrms | 0.38 Apeak | 3000µH |
| | | Aux | 2 - 1 | 22 | 8.5 - 17 Vdc | 0.1 Adc | |
| | | S1 | 9 - 10 | 24 | 9 - 18 Vdc | 0.5 Adc | |

Examples of application with Integrated Circuits :

| MYRRA P / N | Control IC Manufacturer | Input voltage | Power | Frequency |
|-------------|-------------------------|---------------|-------|-----------|
| 74001 | Power Integrations | 85 - 265Vrms | 6w | 132kHz |
| | ST Microelectronics | 85 - 265Vrms | 6w | 70kHz |
| | ST Microelectronics | 85 - 265Vrms | 3w | 40kHz |
| | Motorola | 85 - 265Vrms | 6w | 100kHz |
| | Infineon | 185 - 265Vrms | 6w | 100kHz |
| 74002 | Power Integrations | 85 - 265Vrms | 6w | 132kHz |
| | ST Microelectronics | 85 - 265Vrms | 6w | 70kHz |
| | ST Microelectronics | 85 - 265Vrms | 3w | 40kHz |
| | Motorola | 85 - 265Vrms | 6w | 100kHz |
| | Infineon | 185 - 265Vrms | 6w | 100kHz |

HIGH FREQUENCY FERRITE
POWER FERRITE TRANSFORMERS



- Primary / Secondary Insulation $\geq 4000V$
- Primary / Auxiliary Insulation $\geq 1500V$
- Creepage distance Primary / Secondary $\geq 6mm$
- Ambient temperature $< 60^{\circ}C$
- Construction conforms to IEC950, IEC335, IEC61558-2-16 for reinforced insulation
- Exclusively uses UL94-V0 listed materials

Bottom View (Pin side)

PIN 3 Removed
PCB Drilling Diameter = 1.1mm

| MYRRA P / N | Output Power maximum | Windings | | | | | |
|-------------|----------------------|----------|--------|-------|--------------|-----------------|---------------------|
| | | | Pins | Turns | Voltage | Current maximum | Inductance (+/-10%) |
| 74003 | 6 w | Pri | 4 - 6 | 120 | 85 - 265Vrms | 0.3 Apeak | 3000µH |
| | | Aux | 2 - 1 | 17 | 8 – 16 Vdc | 0.1 Adc | |
| | | S1 | 9 - 10 | 5 | 2 – 4 Vdc | 1.8 Adc | |
| | | S2 | 7 - 10 | 7 | 3 – 6 Vdc | 1.2 Adc | |

Examples of application with Integrated Circuits :

| MYRRA P / N | Control IC Manufacturer | Input voltage | Power | Frequency |
|-------------|-------------------------|---------------|-------|-----------|
| 74003 | Power Integrations | 85 - 265Vrms | 5w | 132kHz |
| | ST Microelectronics | 85 - 265Vrms | 6w | 70kHz |
| | ST Microelectronics | 85 - 265Vrms | 3w | 40kHz |
| | Motorola | 85 - 265Vrms | 6w | 100kHz |
| | Infineon | 185 - 265Vrms | 6w | 100kHz |

HIGH FREQUENCY FERRITE
POWER FERRITE TRANSFORMERS



- Primary / Secondary Insulation ≥ 4000 V
- Primary / Auxiliary Insulation ≥ 1500 V
- Creepage distance Primary / Secondary ≥ 6 mm
- Ambient temperature $< 50^{\circ}\text{C}$
- Construction conforms to IEC950, IEC335, IEC61558-2-16 for reinforced insulation
- Exclusively uses UL94 V-0 listed materials

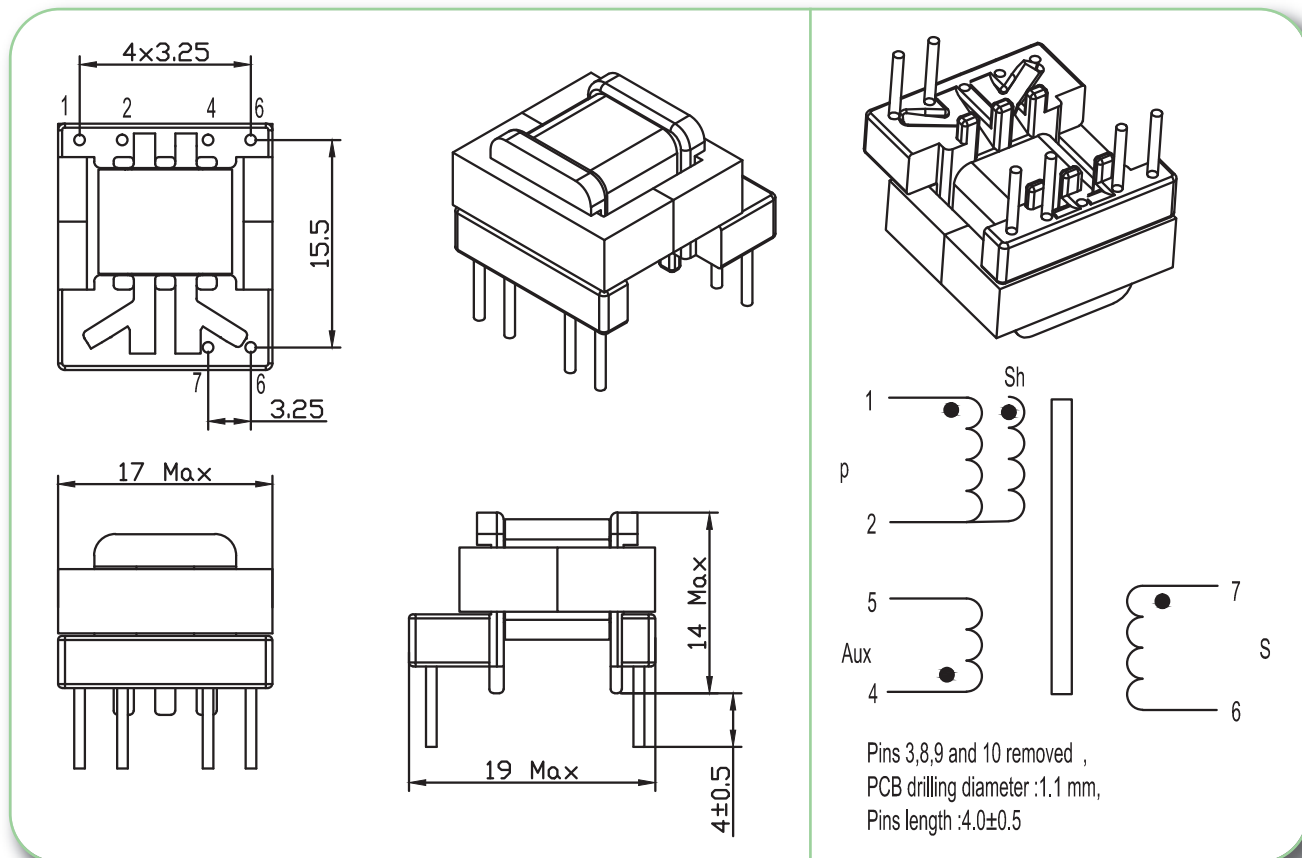

| MYRRA P/N | Output Power maximum | Windings | | | | | |
|-----------|----------------------|----------|--------|-------|--------------|-----------------|---------------------|
| | | | Pins | Turns | Voltage | Current maximum | Inductance (+/-10%) |
| 74004 | 1.7 w | Pri | 1 - 2 | 108 | 85 - 265Vrms | 0.28 Apeak | 2700 μH |
| | | Aux | 5 - 4 | 25 | 22 Vdc | 0.1 Adc | |
| | | S | 7 - 6 | 8 | 6 Vdc | 0.5 Adc | |
| | | Shield | NC - 2 | 8 | | | |

Examples of application with Integrated Circuits :

| MYRRA P/N | Control IC Manufacturer | Control IC P/N | Input voltage | Power | Frequency |
|-----------|-------------------------|----------------|----------------|-------|-----------|
| 74004 | Power Integrations | LNK562 | 185 - 265 Vrms | 1.3 W | 66 kHz |
| | Power integrations | LNK562 | 85 - 265 Vrms | 1.3 W | 66 kHz |
| | Power Integrations | LNK563 | 185 - 265 Vrms | 1.7 W | 83 kHz |
| | Power Integrations | LNK563 | 85 - 265 Vrms | 1.7 W | 83 kHz |
| | Power Integrations | LNK564 | 185 - 265 Vrms | 2.0 W | 100 kHz |
| | Power Integrations | LNK564 | 85 - 265 Vrms | 2.0 W | 100 kHz |

Remarks : This transformer perfectly fulfils the specification of Power Integrations AN-39 Appendix - A.

HIGH FREQUENCY FERRITE POWER FERRITE TRANSFORMERS



- Primary / Secondary Insulation ≥ 4000 V
- Primary / Auxiliary Insulation ≥ 1500 V
- Creepage distance Primary / Secondary ≥ 6 mm
- Ambient temperature $< 50^{\circ}\text{C}$
- Construction conforms to IEC950, IEC335, IEC61558-2-16 for reinforced insulation
- Exclusively uses UL94 V-0 listed materials

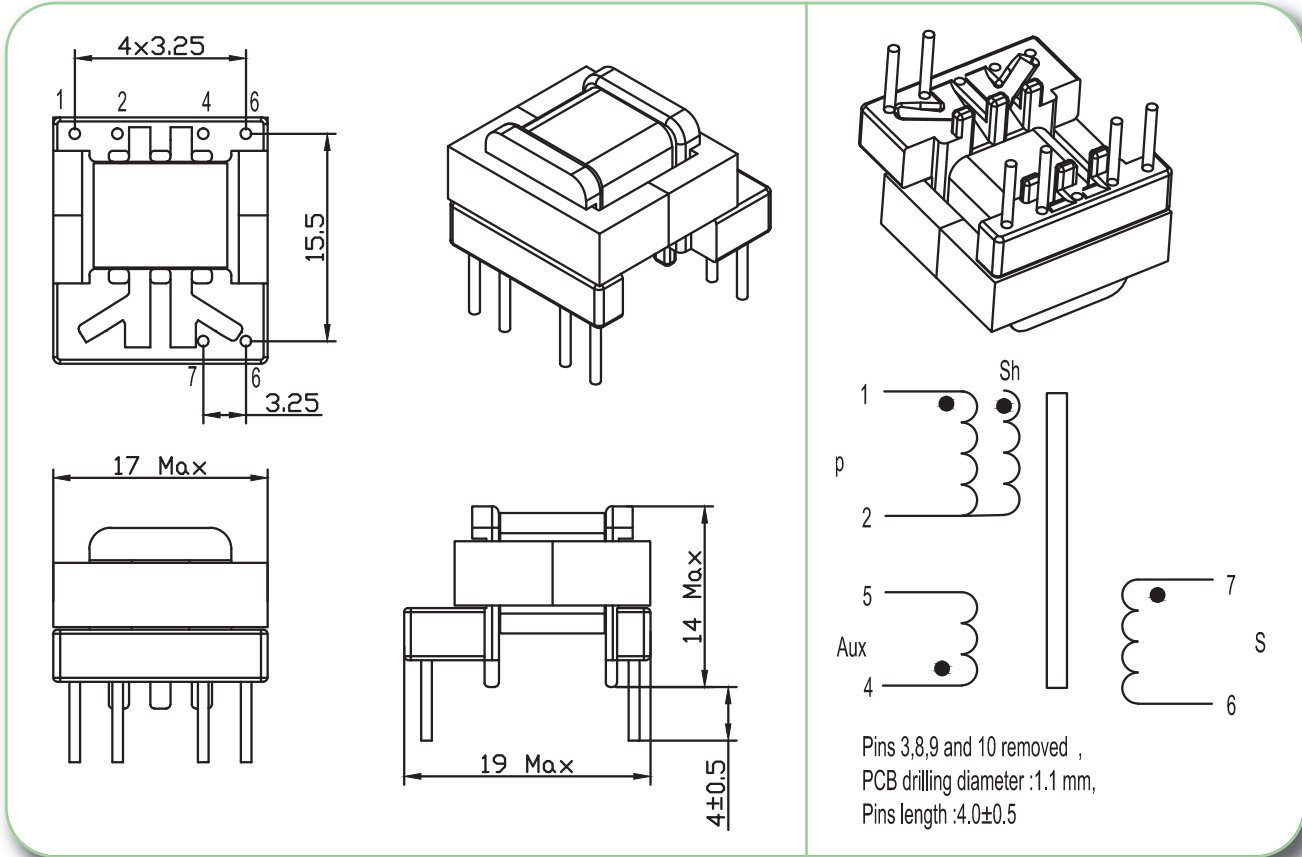

| MYRRA P/N | Output Power maximum | Windings | | | | | |
|-----------|----------------------|----------|-------|--------|--------------|-----------------|---------------------|
| | | | Pins | Turns | Voltage | Current maximum | Inductance (+/-10%) |
| 74005 | 1.7 w | Pri | 1 - 2 | 108 | 85 - 265Vrms | 0.28 Apeak | 2700 μH |
| | Aux | 5 - 4 | 25 | 22 Vdc | 0.1 Adc | | |
| | S | 7 - 6 | 12 | 10 Vdc | 0.2 Adc | | |
| | Shield | NC - 2 | 8 | | | | |

Examples of application with Integrated Circuits :

| MYRRA P/N | Control IC Manufacturer | Control IC P/N | Input voltage | Power | Frequency |
|-----------|-------------------------|----------------|----------------|-------|-----------|
| 74005 | Power Integrations | LNK562 | 185 - 265 Vrms | 1.3 W | 66 kHz |
| | Power integrations | LNK562 | 85 - 265 Vrms | 1.3 W | 66 kHz |
| | Power Integrations | LNK563 | 185 - 265 Vrms | 1.7 W | 83 kHz |
| | Power Integrations | LNK563 | 85 - 265 Vrms | 1.7 W | 83 kHz |
| | Power Integrations | LNK564 | 185 - 265 Vrms | 2.0 W | 100 kHz |
| | Power Integrations | LNK564 | 85 - 265 Vrms | 2.0 W | 100 kHz |

Remarks : This transformer perfectly fulfils the specification of Power Integrations AN-39 Appendix - B.



- Primary / Secondary Insulation $\geq 4000V$
- Primary / Auxiliary Insulation $\geq 1500V$
- Creepage distance Primary / Secondary $\geq 6mm$
- Ambient temperature $< 50^{\circ}C$
- Construction conforms to IEC950, IEC335, IEC61558-2-16 for reinforced insulation
- Exclusively uses UL94-V0 listed materials

18 Max
17.5 Max
16 Max
5±0.5
2.7±0.2
3.5±0.2
5x2.7
12.2±0.5
10
Ø0.6
3x3.5

Bottom View (Pin side)

+E 6
DRAIN 4
+AUX 2
0V 1

7 8 9 10
+S2
0V
+S1
0V

74010

PIN 3 Removed
PCB Drilling Diameter = 1.1mm

| MYRRA P / N | Output Power maximum | Windings | | | | | |
|-------------|----------------------|----------|--------|-------|--------------|-----------------|---------------------|
| | | | Pins | Turns | Voltage | Current maximum | Inductance (+/-10%) |
| 74010 | 12 w | Pri | 4 - 6 | 120 | 85 - 265Vrms | 0.55 Apeak | 1660µH |
| | | Aux | 2 - 1 | 14 | 7 - 14 Vdc | 0.1 Adc | |
| | | S1 | 9 - 10 | 7 | 3.3 - 7 Vdc | 2 Adc | |
| | | S2 | 7 - 8 | 17 | 8 - 17 Vdc | 1 Adc | |

Examples of application with Integrated Circuits :

| MYRRA P / N | Control IC Manufacturer | Input voltage | Power | Frequency |
|-------------|-------------------------|---------------|--------|-----------|
| 74010 | Power Integrations | 185 - 265Vrms | 12w | 132kHz |
| | Power Integrations | 85 - 265Vrms | 10w | 132kHz |
| | Power Integrations | 185 - 265Vrms | 12w | 132kHz |
| | Power Integrations | 85 - 265Vrms | 10w | 132kHz |
| | Power Integrations | 185 - 265Vrms | 12w | 132kHz |
| | ST Microelectronics | 85 - 265Vrms | 8w | 70kHz |
| | ST Microelectronics | 185 - 265Vrms | 10w | 70kHz |
| | Motorola | 85 - 265Vrms | 8w | 100kHz |
| | Motorola | 185 - 265Vrms | 10w | 100kHz |
| | Infineon | 92 - 265Vrms | 7,5w | 100kHz |
| | Infineon | 185 - 265Vrms | 10w | 100kHz |
| | Fairchild | 85 - 265Vrms | 7w | 50kHz |
| Fairchild | 185 - 265Vrms | 10w | 100kHz | |

HIGH FREQUENCY FERRITE
POWER FERRITE TRANSFORMERS



- Primary / Secondary Insulation $\geq 4000V$
- Primary / Auxiliary Insulation $\geq 1500V$
- Creepage distance Primary / Secondary $\geq 6mm$
- Ambient temperature $< 50^{\circ}C$
- Construction conforms to IEC950, IEC335, IEC61558-2-16 for reinforced insulation
- Exclusively uses UL94-V0 listed materials

18 Max
17.5 Max
16 Max
5±0.5
2.7±0.2
6
7
3.5±0.2
5x2.7
10
12.2±0.5
Ø0.6
3x3.5

Bottom View (Pin side)

74014

+E 6
 DRAIN 4
 +AUX 2
 0V 1

7 +S2
 8 0V
 9 +S1
 10 0V

PIN 3 Removed
PCB Drilling Diameter = 1.1mm

| MYRRA P / N | Output Power maximum | Windings | | | | | |
|-------------|----------------------|----------|--------|-------|--------------|-----------------|---------------------|
| | | | Pins | Turns | Voltage | Current maximum | Inductance (+/-10%) |
| 74014 | 12 w | Pri | 4 - 6 | 120 | 85 - 265Vrms | 0.5 Apeak | 1800µH |
| | | Aux | 2 - 1 | 17 | 9 – 18 Vdc | 0.2 Adc | |
| | | S1 | 9 - 10 | 27 | 15 – 30 Vdc | 0.4 Adc | |
| | | S2 | 7 - 8 | 27 | 15 – 30 Vdc | 0.4 Adc | |

Typical outputs :
 +24V 0.5A with S1 – S2 in parallel
 +48V 0.25A with S1 – S2 in series (8-9 connected)
 +15V / -15V 0.4A with pins 8-9 connected to 0V

Examples of application with Integrated Circuits :

| MYRRA P / N | Control IC Manufacturer | Input voltage | Power | Frequency |
|-------------|-------------------------|---------------|-------|-----------|
| 74014 | Power Integrations | 185 - 265Vrms | 12w | |
| | Power Integrations | 85 - 265Vrms | 8w | |
| | Power Integrations | 185 - 265Vrms | 12w | 132kHz |
| | Power Integrations | 85 - 265Vrms | 8w | 132kHz |

HIGH FREQUENCY FERRITE
POWER FERRITE TRANSFORMERS



- Primary / Secondary Insulation $\geq 4000V$
- Primary / Auxiliary Insulation $\geq 1500V$
- Creepage distance Primary / Secondary $\geq 6mm$
- Ambient temperature $< 50^{\circ}C$
- Construction conforms to IEC950, IEC335, IEC61558-2-16 for reinforced insulation
- Exclusively uses UL94-V0 listed materials

18 Max
17.5 Max
16 Max
5±0.5
2.7±0.2
6
7
3.5±0.2
5x2.7
10
12.2±0.5
Ø0.6
3x3.5

Bottom View (Pin side)

+E 6
DRAIN 4
+AUX 2
0V 1

7
8
9
10

+S3
+S2
+S1
0V

74015

PIN 3 Removed
PCB Drilling Diameter = 1.1mm

HIGH FREQUENCY FERRITE
POWER FERRITE TRANSFORMERS

| MYRRA P / N | Output Power maximum | Windings | | | | | |
|-------------|----------------------|----------|--------|-------|--------------|-----------------|---------------------|
| | | | Pins | Turns | Voltage | Current maximum | Inductance (+/-10%) |
| 74015 | 12 w | Pri | 4 - 6 | 120 | 85 - 265Vrms | 0.5 Apeak | 1800µH |
| | | Aux | 2 - 1 | 14 | 12 Vdc | 0.2 Adc | |
| | | S1 | 9 - 10 | 6 | 5 Vdc | 1.5 Adc | |
| | | S2 | 8 - 10 | 17 | 15 Vdc | 0.6 Adc | |
| | | S3 | 7 - 10 | 27 | 24 Vdc | 0.4 Adc | |

Examples of application with Integrated Circuits :

| MYRRA P / N | Control IC Manufacturer | Input voltage | Power | Frequency |
|-------------|-------------------------|---------------|-------|-----------|
| 74015 | Power Integrations | 185 - 265Vrms | 10w | |
| | Power Integrations | 85 - 265Vrms | 8w | |
| | Power Integrations | 185 - 265Vrms | 12w | 132kHz |
| | Power Integrations | 85 - 265Vrms | 9w | 132kHz |



- Primary / Secondary Insulation $\geq 4000V$
- Primary / Auxiliary Insulation $\geq 1500V$
- Creepage distance Primary / Secondary $\geq 6mm$
- Ambient temperature $< 50^{\circ}C$
- Construction conforms to IEC950, IEC335, IEC61558-2-16 for reinforced insulation
- Exclusively uses UL94-V0 listed materials

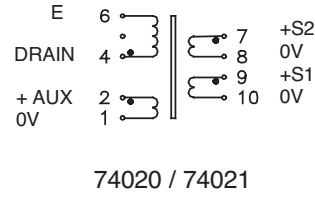
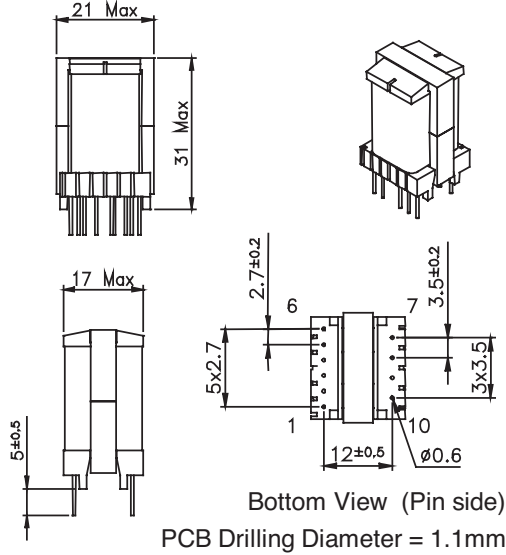

| MYRRA P / N | Output Power maximum | Windings | | | | | |
|-------------|----------------------|----------|--------|-------|--------------|-----------------|---------------------|
| | | | Pins | Turns | Voltage | Current maximum | Inductance (+/-10%) |
| 74020 | 18 w | Pri | 4 - 6 | 108 | 85 - 265Vrms | 0.8 Apeak | 1250µH |
| | | Aux | 2 - 1 | 12 | 7 - 14 Vdc | 0.1 Adc | |
| | | S1 | 9 - 10 | 6 | 3.3 - 7 Vdc | 3 Adc | |
| | | S2 | 7 - 8 | 14 | 8 - 16.5 Vdc | 1.4 Adc | |
| 74021 | 18 w | Pri | 4 - 6 | 108 | 85 - 265Vrms | 1.1 Apeak | 900µH |
| | | Aux | 2 - 1 | 12 | 7 - 14 Vdc | 0.1 Adc | |
| | | S1 | 9 - 10 | 6 | 3.3 - 7 Vdc | 3 Adc | |
| | | S2 | 7 - 8 | 14 | 8 - 16.5 Vdc | 1.4 Adc | |

Examples of application with Integrated Circuits :

| MYRRA P / N | Control IC Manufacturer | Input voltage | Power | Frequency |
|-------------|-------------------------|---------------|-------|-----------|
| 74020 | Power Integrations | 85 - 265Vrms | 15w | 132kHz |
| | Power Integrations | 185 - 265Vrms | 18w | 132kHz |
| | Power Integrations | 85 - 265Vrms | 12w | 132kHz |
| | ST Microelectronics | 85 - 265Vrms | 10w | 100kHz |
| | ST Microelectronics | 185 - 265Vrms | 12w | 100kHz |
| | ST Microelectronics | 185 - 265Vrms | 16w | 100kHz |
| | Motorola | 185 - 265Vrms | 16w | 100kHz |
| | Infineon | 185 - 265Vrms | 16w | 100kHz |
| 74021 | ST Microelectronics | 85 - 265Vrms | 13w | 70kHz |
| | Motorola | 85 - 265Vrms | 13w | 100kHz |
| | Infineon | 92 - 265Vrms | 10w | 100kHz |



- Primary / Secondary Insulation $\geq 4000V$
- Primary / Auxiliary Insulation $\geq 1500V$
- Creepage distance Primary / Secondary $\geq 6mm$
- Ambient temperature $< 60^{\circ}C$
- Construction conforms to IEC950, IEC335, IEC61558-2-16 for reinforced insulation
- Exclusively uses UL94-V0 listed materials

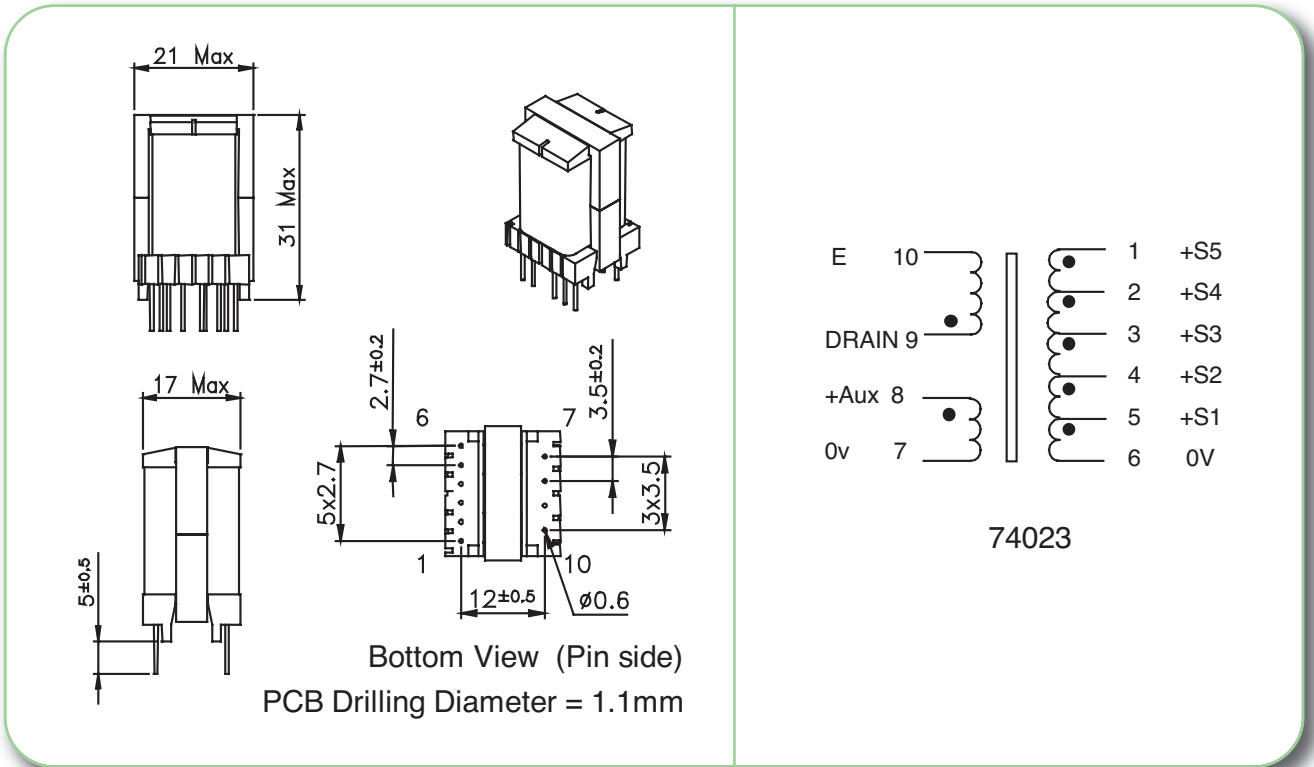

| MYRRA P/N | Output Power maximum | Windings | | | | | |
|-----------|----------------------|----------|--------|-------|--------------|-----------------|---------------------|
| | | | Pins | Turns | Voltage | Current maximum | Inductance (+/-10%) |
| 74023 | 16 w | Pri | 9 – 10 | 120 | 85 - 265Vrms | 0.85 Apeak | 1250µH |
| | | Aux | 8 – 7 | 17 | 15 Vdc | 0.2 Adc | |
| | | S1 | 5 – 6 | 4 | 3.3 Vdc | S1 + S2 : 7 Adc | |
| | | S2 | 4 – 6 | 6 | 5 Vdc | S1 + S2 : 7 Adc | |
| | | S3 | 3 – 6 | 14 | 12 Vdc | 0.8 Adc | |
| | | S4 | 2 – 6 | 20 | 18 Vdc | 0.8 Adc | |
| | | S5 | 1 – 6 | 33 | 30 Vdc | 0.2 Adc | |

Examples of application with Integrated Circuits :

| MYRRA P/N | Control IC Manufacturer | Input voltage | Power | Frequency |
|-----------|-------------------------|---------------|-------|-----------|
| 74023 | Power Integrations | 185 - 265Vrms | 16w | 132kHz |
| | Power Integrations | 85 - 265Vrms | 12w | 132kHz |

HIGH FREQUENCY FERRITE
POWER FERRITE TRANSFORMERS



- Primary / Secondary Insulation $\geq 4000V$ • Primary / Auxiliary Insulation $\geq 1500V$
- Creepage distance Primary / Secondary $\geq 8mm$
- Ambient temperature $< 50^{\circ}C$
- Construction conforms to IEC950, IEC335, IEC61558-2-16 for reinforced insulation
- Exclusively uses UL94-V0 listed materials

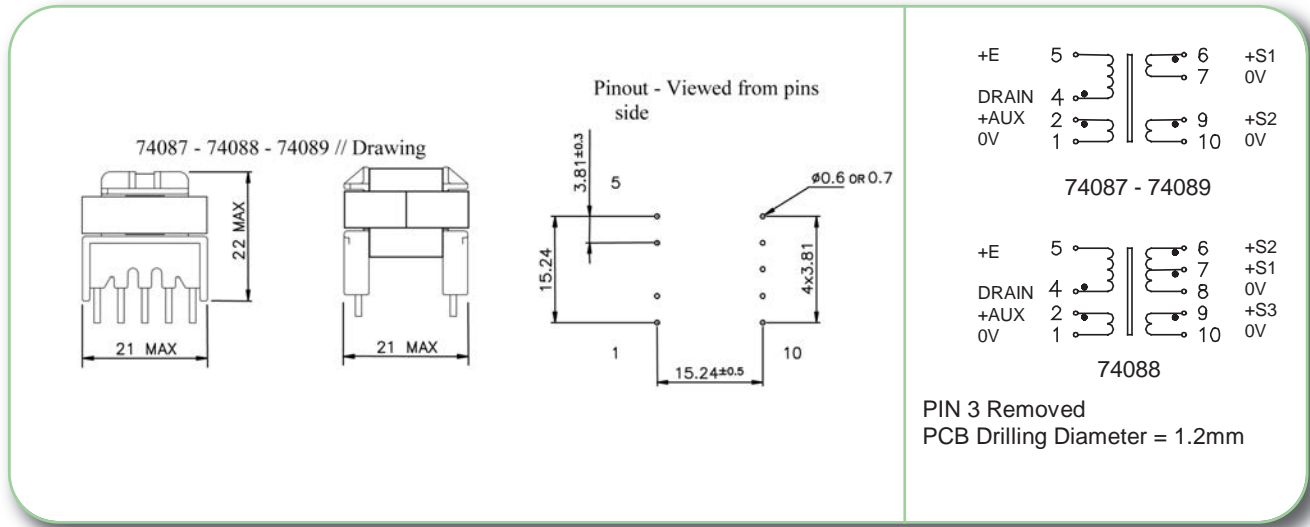

| MYRRA P / N | Output Power maximum | Windings | | | | | |
|-------------|----------------------|----------|--------|-------|--------------|-----------------|---------------------|
| | | | Pins | Turns | Voltage | Current maximum | Inductance (+/-10%) |
| 74087 | 24 w | Pri | 4 – 5 | 86 | 85 - 265Vrms | 1.0 Apeak | 1000µH |
| | | Aux | 2 – 1 | 12 | 11 - 18 Vdc | 0.3 Adc | |
| | | S1 | 6 – 7 | 10 | 9 – 15 Vdc | 1.5 Adc | |
| | | S2 | 9 – 10 | 10 | 9 – 15 Vdc | 1.5 Adc | |
| 74088 | 20 w | Pri | 4 – 5 | 80 | 85 - 265Vrms | 0.9 Apeak | 1100µH |
| | | Aux | 2 – 1 | 17 | 15 Vdc | 0.3 Adc | |
| | | S1 | 7 – 8 | 4 | 3.3 Vdc | S1 + S2 : 7 Adc | |
| | | S2 | 6 – 8 | 6 | 5 Vdc | S1 + S2 : 7 Adc | |
| | | S3 | 9 – 10 | 14 | 12 Vdc | 1.3 Adc | |
| 74089 | 20 w | Pri | 4 – 5 | 86 | 85 - 265Vrms | 0.85 Apeak | 1300µH |
| | | Aux | 2 – 1 | 12 | 7 - 18 Vdc | 0.3 Adc | |
| | | S1 | 6 – 7 | 5 | 3 – 7.5 Vdc | 2.0 Adc | |
| | | S2 | 9 – 10 | 5 | 3 – 7.5 Vdc | 2.0 Adc | |

Examples of application with Integrated Circuits :

| MYRRA P / N | Control IC Manufacturer | Input voltage | Power | Frequency |
|-------------|-------------------------|---------------|-------|-----------|
| 74087 | Power Integrations | 185 - 265Vrms | 24w | 132kHz |
| | Power Integrations | 85 - 265Vrms | 15w | 132kHz |
| 74088 | Power Integrations | 185 - 265Vrms | 20w | 132kHz |
| | Power Integrations | 85 – 265Vrms | 12w | 132kHz |
| 74089 | Power Integrations | 185 - 265Vrms | 20w | 132kHz |
| | Power Integrations | 85 – 265Vrms | 14w | 132kHz |
| | Power Integrations | 185 - 265Vrms | 17w | < 120kHz |

HIGH FREQUENCY FERRITE
POWER FERRITE TRANSFORMERS



- Primary / Secondary Insulation $\geq 4000V$
- Primary / Auxiliary Insulation $\geq 1500V$
- Creepage distance Primary / Secondary $\geq 6mm$
- Ambient temperature $< 50^{\circ}C$
- Construction conforms to IEC950, IEC335, IEC61558-2-16 for reinforced insulation
- Exclusively uses UL94-V0 listed materials

Technical drawings showing dimensions and pin configurations for transformer models 74030 and 74032. The drawings include top and bottom views with dimensions such as 27 Max, 21 Max, 5±0.5, 15.24±0.5, 4x5.08, and 5.08±0.2. Pin configurations are detailed for both models, with Pin 4 noted as removed and a PCB drilling diameter of 1.4mm specified.

| MYRRA P / N | Output Power maximum | Windings | | | | | |
|-------------|----------------------|----------|------|-------|--------------|-----------------|---------------------|
| | | | Pins | Turns | Voltage | Current maximum | Inductance (+/-10%) |
| 74030 | 30 w | Pri | 3-5 | 70 | 85 - 265Vrms | 1.5 Apeak | 750µH |
| | | Aux | 2-1 | 8 | 7 - 14.5 Vdc | 1 Adc | |
| | | S1 | 7-8 | 4 | 3.3 - 7 | 3 Adc | |
| | | S2 | 6-8 | 9 | 8 - 16 Vdc | 1.5 Adc | |
| | | S3 | 9-10 | 9 | 8 - 16 Vdc | 1.5 Adc | |
| 74032 | 35 w | Pri | 3-5 | 72 | 85 - 265Vrms | 1.1 Apeak | 1100µH |
| | | Aux | 2-1 | 10 | 8 - 16 Vdc | 1 Adc | |
| | | S1 | 6-10 | 18 | 15 - 30 Vdc | 1.4 Adc | |

Note for 74030 : S2 and S3 can be connected in series or in parallel

Examples of application with Integrated Circuits :

| MYRRA P / N | Control IC Manufacturer | Input voltage | Power | Frequency |
|-------------|-------------------------|---------------|-------|--------------|
| 74030 | Power Integrations | 185 - 265Vrms | 30w | 132kHz |
| | Power Integrations | 85 - 265Vrms | 25w | 66 or 132kHz |
| | ST Microelectronics | 85 - 265Vrms | 22w | 70kHz |
| | ST Microelectronics | 185 - 265Vrms | 30w | 70kHz |
| | Motorola | 85 - 265Vrms | 22w | 100kHz |
| | Motorola | 185 - 265Vrms | 30w | 100kHz |
| | Infineon | 185 - 265Vrms | 30w | 100kHz |
| | Fairchild | 85 - 265Vrms | 22w | 100kHz |
| 74032 | Power Integrations | 185 - 265Vrms | 25w | 132kHz |

HIGH FREQUENCY FERRITE
POWER FERRITE TRANSFORMERS



- Primary / Secondary Insulation $\geq 4000V$
- Primary / Auxiliary Insulation $\geq 1500V$
- Creepage distance Primary / Secondary $\geq 8mm$
- Ambient temperature $< 50^{\circ}C$
- Construction conforms to IEC950, IEC335, IEC61558-2-16 for reinforced insulation
- Exclusively uses UL94-V0 listed materials

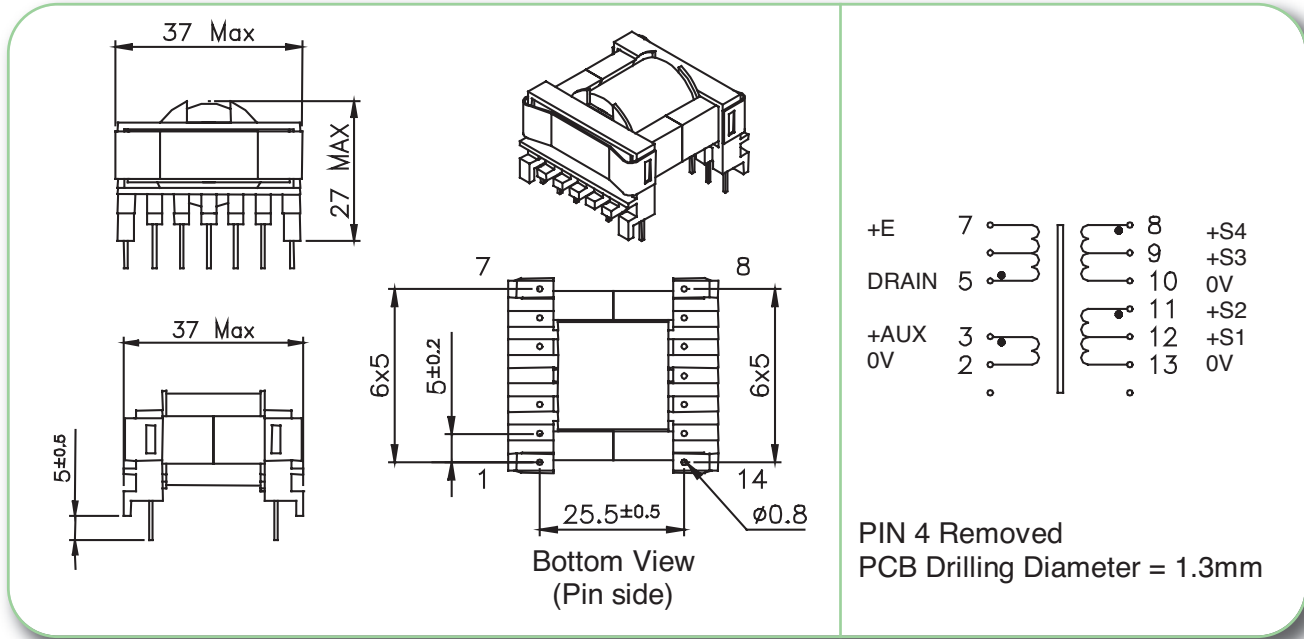

| MYRRA P / N | Output Power maximum | Windings | | | | | |
|-------------|----------------------|----------|---------|-------|--------------|-----------------|---------------------|
| | | | Pins | Turns | Voltage | Current maximum | Inductance (+/-10%) |
| 74040 | 60 w | Pri | 5 - 7 | 50 | 85 - 265Vrms | 3.0 Apeak | 500µH |
| | | Aux | 3 - 2 | 6 | 7 - 14.5 Vdc | 0.5 Adc | |
| | | S1 | 12 - 13 | 3 | 3.3 - 7 | 4 Adc | |
| | | S2 | 11 - 13 | 7 | 8 - 16.5 Vdc | 2.5 Adc | |
| | | S3 | 9 - 10 | 3 | 3.3 - 7 | 4 Adc | |
| | | S4 | 8 - 10 | 7 | 8 - 16.5 Vdc | 2.5 Adc | |

Note : S1 / S3 or S2 / S4 can be connected in series or in parallel

Examples of application with Integrated Circuits :

| MYRRA P / N | Control IC Manufacturer | Input voltage | Power | Frequency |
|-------------|-------------------------|---------------|-------|--------------|
| 74040 | Power Integrations | 185 - 265Vrms | 60w | 66 or 132kHz |
| | Power Integrations | 85 - 265Vrms | 45w | 66 or 132kHz |
| | ST Microelectronics | 85 - 265Vrms | 35w | 100kHz |
| | ST Microelectronics | 185 - 265Vrms | 45w | 100kHz |
| | Motorola | 85 - 265Vrms | 35w | 100kHz |
| | Motorola | 185 - 265Vrms | 45w | 100kHz |
| | Infineon | 92 - 265Vrms | 35w | 100kHz |
| | Infineon | 185 - 265Vrms | 45w | 100kHz |



- Primary / Secondary Insulation $\geq 4000V$
- Primary / Auxiliary Insulation $\geq 1500V$
- Creepage distance Primary / Secondary $\geq 6mm$
- Ambient temperature $< 50^{\circ}C$
- Construction conforms to IEC950, IEC335, IEC61558-2-16 for reinforced insulation
- Exclusively uses UL94-V0 listed materials

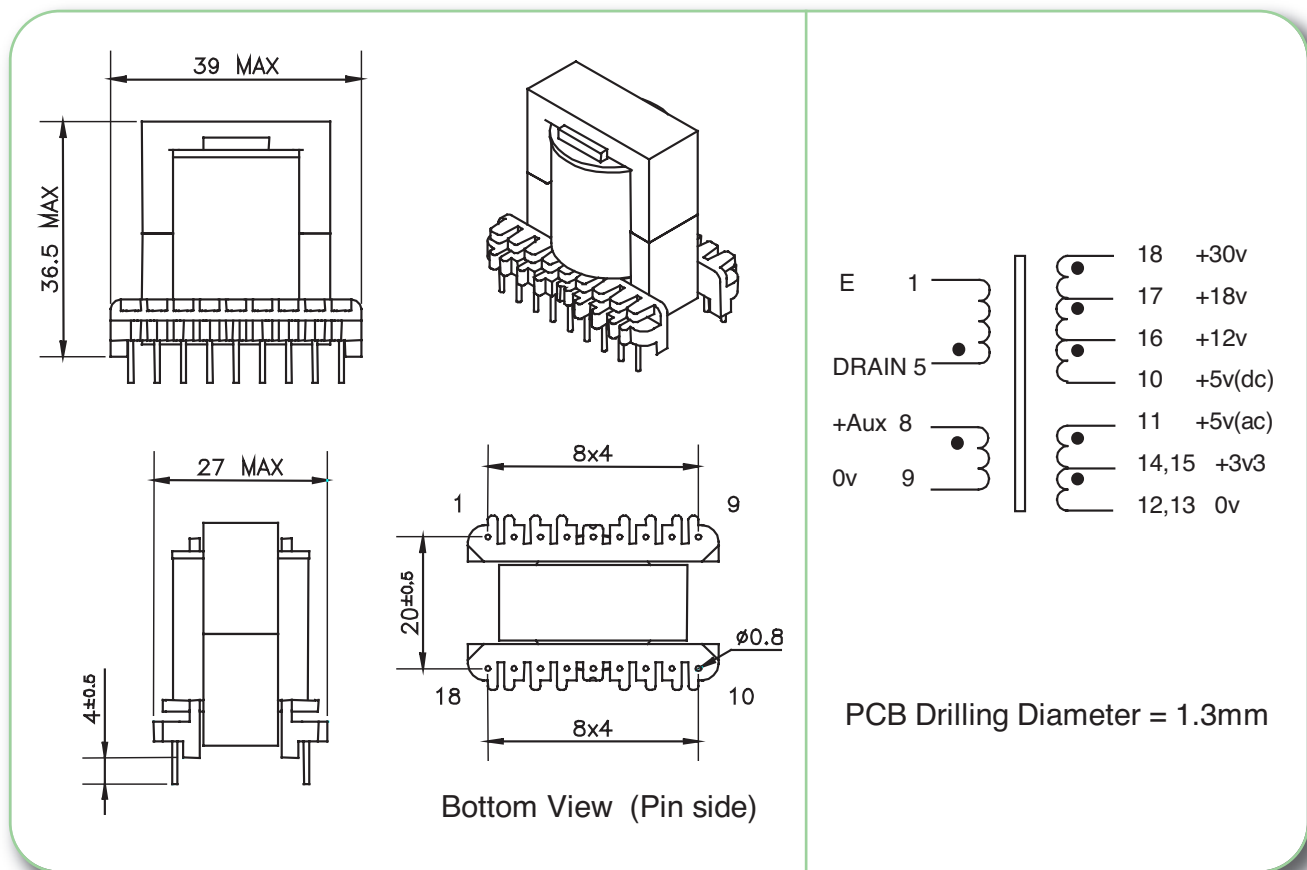

HIGH FREQUENCY FERRITE
POWER FERRITE TRANSFORMERS

| MYRRA P / N | Output Power maximum | Windings | | | | | |
|----------------|----------------------------|----------|---------------|-------|--------------|--------------------|------------------------|
| | | | Pins | Turns | Voltage | Current maximum | Inductance (+/-10%) |
| 74043 | 60w | Pri | 5-1 | 45 | 85 - 265Vrms | 3 Apeak | 500µH |
| | | Aux | 8-9 | 7 | 15 Vdc | 0.5 Adc | |
| | | S1 | 14+15 / 12+13 | 2 | 3.3 Vdc | S1+S2 : 7 Adc | |
| | | S2 | 11 / 12+13 | 3 | 5 Vdc | S1+S2 : 7 Adc | |
| | | S3 | 16-10 | 4 | 12 Vdc | 2 Adc | |
| | | S4 | 17-10 | 7 | 18 Vdc | 2 Adc | |
| | | S5 | 18-10 | 13 | 30 Vdc | 0.5 Adc | |

Examples of application with Integrated Circuits :

| MYRRA P / N | Control IC Manufacturer | Input voltage | Power | Frequency |
|----------------|----------------------------|---------------|-------|--------------|
| 74043 | Power Integrations | 185 - 265Vrms | 60w | 66 or 132kHz |
| | Power Integrations | 85 - 265Vrms | 45w | 66 or 132kHz |



- Primary / Secondary Insulation $\geq 4000V$
- Primary / Auxiliary Insulation $\geq 1500V$
- Creepage distance Primary / Secondary $\geq 8mm$
- Ambient temperature $< 50^{\circ}C$
- Construction conforms to IEC950, IEC335, IEC61558-2-16 for reinforced insulation
- Exclusively uses UL94-V0 listed materials

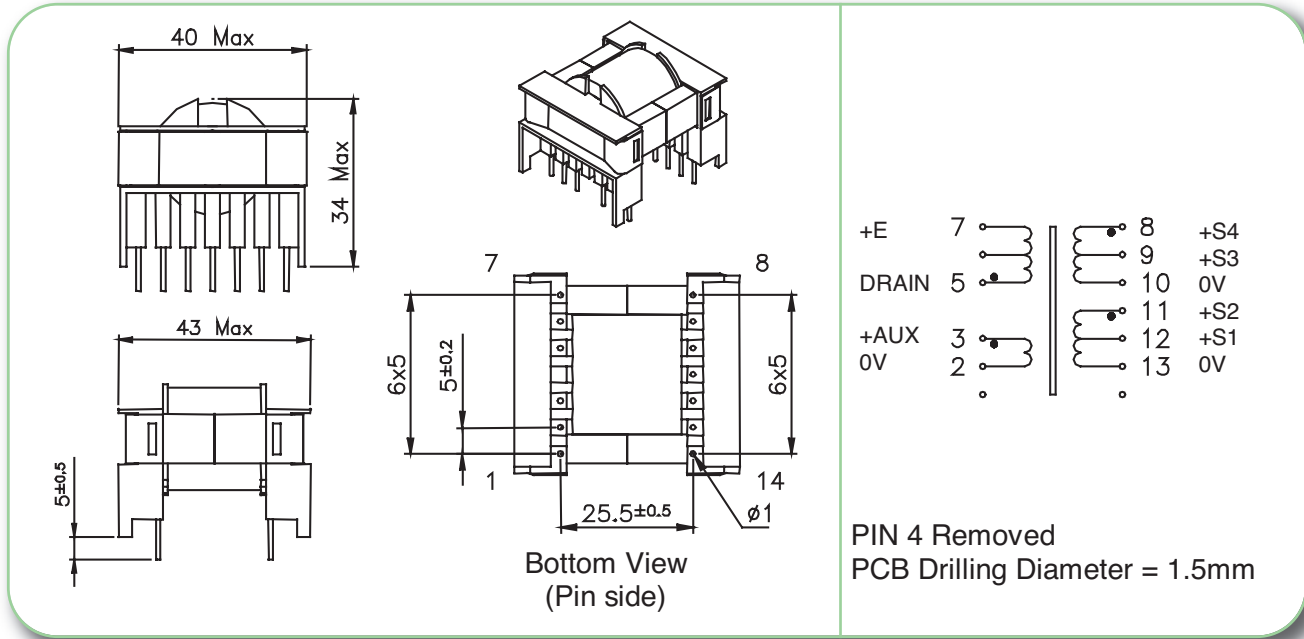

| MYRRA P / N | Output Power maximum | Windings | | | | | |
|-------------|----------------------|----------|---------|-------|--------------|-----------------|---------------------|
| | | | Pins | Turns | Voltage | Current maximum | Inductance (+/-10%) |
| 74050 | 90 w | Pri | 5 - 7 | 36 | 85 - 265Vrms | 2.8 Apeak | 500µH |
| | | Aux | 3 - 2 | 4 | 7 - 14 Vdc | 0.5 Adc | |
| | | S1 | 12 - 13 | 2 | 3.3 - 6.5 | 5 Adc | |
| | | S2 | 11 - 13 | 5 | 8.5 - 17 Vdc | 3 Adc | |
| | | S3 | 9 - 10 | 2 | 3.3 - 6.5 | 5 Adc | |
| | | S4 | 8 - 10 | 5 | 8.5 - 17 Vdc | 3 Adc | |

Note : S1 / S3 or S2 / S4 can be connected in series or in parallel

Examples of application with Integrated Circuits :

| MYRRA P / N | Control IC Manufacturer | Input voltage | Power | Frequency |
|-------------|-------------------------|---------------|-------|--------------|
| 74050 | Power Integrations | 185 - 265Vrms | 90w | 132kHz |
| | Power Integrations | 85 - 265Vrms | 60w | 66 or 132kHz |
| | ST Microelectronics | 185 - 265Vrms | 80w | 70kHz |
| | ST Microelectronics | 85 - 265Vrms | 60w | 70kHz |
| | Motorola | 185 - 265Vrms | 80w | 100kHz |
| | Motorola | 85 - 265Vrms | 60w | 100kHz |
| | Infineon | 185 - 265Vrms | 80w | 100kHz |
| | Infineon | 85 - 265Vrms | 60w | 100kHz |



- Primary / Secondary Insulation $\geq 4000V$
- Primary / Auxiliary Insulation $\geq 1500V$
- Creepage distance Primary / Secondary $\geq 8mm$
- Ambient temperature $< 50^{\circ}C$
- Construction conforms to IEC950, IEC335, IEC61558-2-16 for reinforced insulation
- Exclusively uses UL94-V0 listed materials

Bottom View (Pin side)

PIN 4 Removed
PCB Drilling Diameter = 1.5mm

| MYRRA P / N | Output Power maximum | Windings | | | | | |
|-------------|----------------------|----------|---------|-------|--------------|-----------------|---------------------|
| | | | Pins | Turns | Voltage | Current maximum | Inductance (+/-10%) |
| 74060 | 140 w | Pri | 5 – 7 | 36 | 85 - 265Vrms | 4 Apeak | 440µH |
| | | Aux | 3 – 2 | 4 | 7 – 14 Vdc | 0.5 A dc | |
| | | S1 | 14 – 15 | 2 | 3.3 – 6.5 | 5 A dc | |
| | | S2 | 13 – 15 | 5 | 8.5 – 17 Vdc | 5 A dc | |
| | | S3 | 11 – 12 | 2 | 3.3 – 6.5 | 5 A dc | |
| | | S4 | 10 – 12 | 5 | 8.5 – 17 Vdc | 5 A dc | |

Note : S1 / S3 or S2 / S4 can be connected in series or in parallel

Examples of application with Integrated Circuits :

| MYRRA P / N | Control IC Manufacturer | Input voltage | Power | Frequency |
|-------------|-------------------------|---------------|--------|--------------|
| 74060 | Power Integrations | 185 - 265Vrms | 140w | 132kHz |
| | Power Integrations | 85 - 265Vrms | 90w | 66 or 132kHz |
| | ST Microelectronics | 85 - 265Vrms | 70w | 70kHz |
| | ST Microelectronics | 185 - 265Vrms | 120w | 100kHz |
| | Motorola | 85 - 265Vrms | 70w | 100kHz |
| | Motorola | 185 - 265Vrms | 120w | 100kHz |
| | Infineon | 85 - 265Vrms | 70w | 100kHz |
| | Infineon | 185 - 265Vrms | 120w | 100kHz |
| | Fairchild | 85 - 265Vrms | 70w | 100kHz |
| Fairchild | 185 - 265Vrms | 120w | 100kHz | |

HIGH FREQUENCY FERRITE
POWER FERRITE TRANSFORMERS



- Primary / Secondary Insulation $\geq 4000V$
- Primary / Auxiliary Insulation $\geq 1500V$
- Creepage distance Primary / Secondary $\geq 8mm$
- Ambient temperature $< 50^{\circ}C$
- Construction conforms to IEC950, IEC335, IEC61558-2-16 for reinforced insulation
- Exclusively uses UL94-V0 listed materials

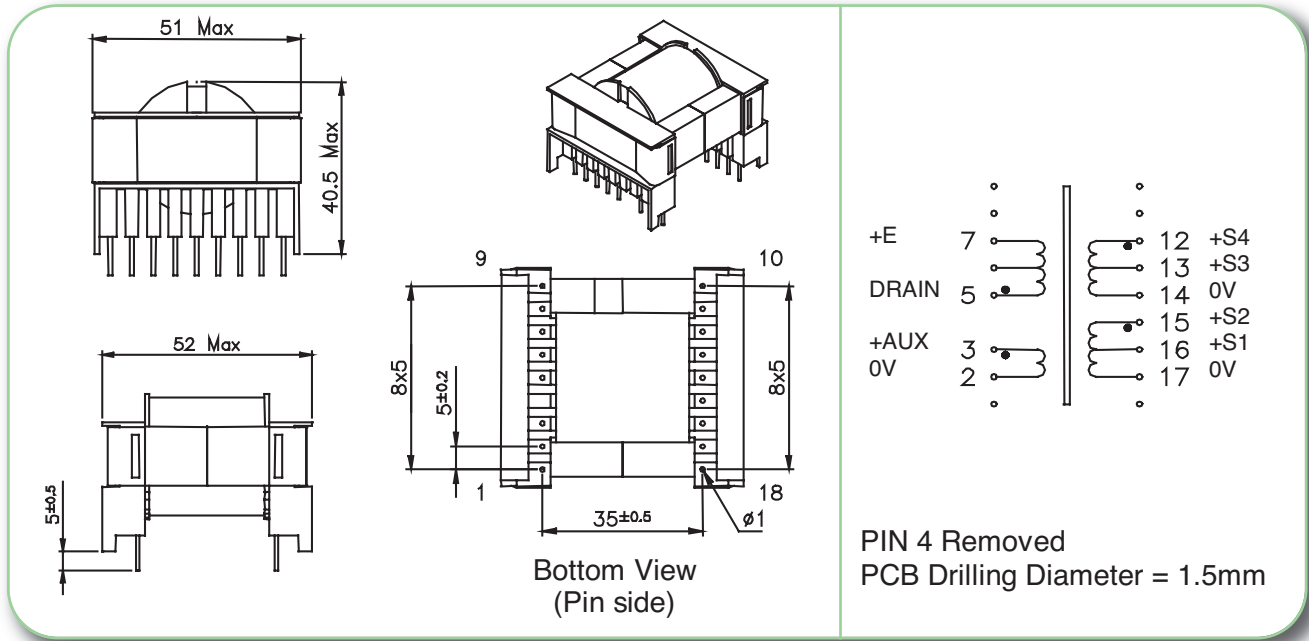

| MYRRA P / N | Output Power maximum | Windings | | | | | |
|-------------|----------------------|----------|---------|-------|--------------|-----------------|---------------------|
| | | | Pins | Turns | Voltage | Current maximum | Inductance (+/-10%) |
| 74070 | 180 w | Pri | 5 – 7 | 38 | 85 - 265Vrms | 8 Apeak | 300μH |
| | | Aux | 3 – 2 | 4 | 7 – 14 Vdc | 0.5 Adc | |
| | | S1 | 16 – 17 | 2 | 3.3 – 6.5 | 6 Adc | |
| | | S2 | 15 – 17 | 5 | 8.5 – 17 Vdc | 5 Adc | |
| | | S3 | 13 – 14 | 2 | 3.3 – 6.5 | 6 Adc | |
| | | S4 | 12 – 14 | 5 | 8.5 – 17 Vdc | 5 Adc | |

Note : S1 / S3 or S2 / S4 can be connected in series or in parallel

Examples of application with Integrated Circuits :

| MYRRA P / N | Control IC Manufacturer | Input voltage | Power | Frequency |
|-------------|-------------------------|---------------|-------|--------------|
| 74070 | Power Integrations | 185 - 265Vrms | 180w | 66 or 132kHz |
| | Power Integrations | 85 - 265Vrms | 120w | 66kHz |
| | Infineon | 185 - 265Vrms | 160w | 100kHz |
| | Fairchild | 185 - 265Vrms | 160w | 100kHz |
| | Philips | 185 - 265Vrms | 120w | 50kHz |

HIGH FREQUENCY FERRITE
POWER FERRITE TRANSFORMERS



1W

2W



5W



10W

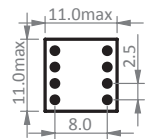
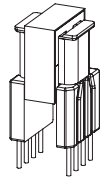

Height : 19.0mm max

E 10
reinforced insulation
creepage distances: 6mm

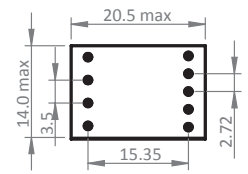
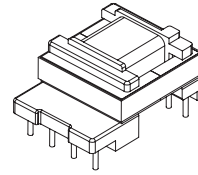

Height : 11mm max

EF 12.6
reinforced insulation
creepage distances: 6mm

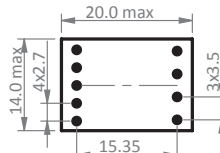
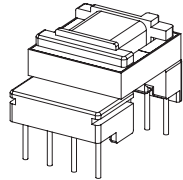

Height : 12.5mm max

EF 12.6
reinforced insulation
creepage distances: 6mm

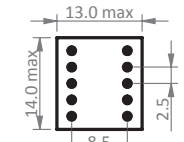
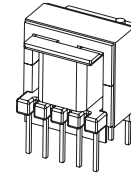

Height : 14.8mm max

E 13
basic insulation

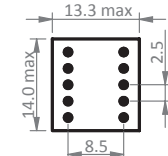
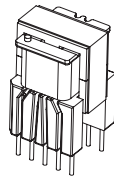

Height : 19.2mm max

E 13
reinforced insulation
creepage distances: 6mm

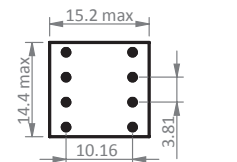
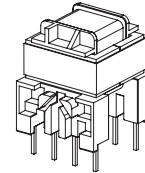

Height : 17.7mm max

E 13
reinforced insulation
creepage distances: 6mm

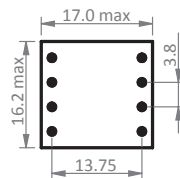
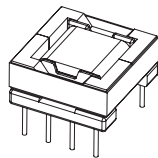

Height : 11mm max

EFD 15
basic insulation

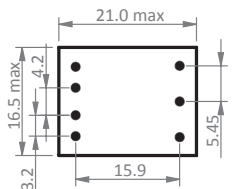
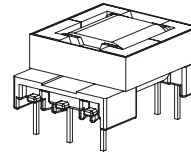

Height : 10.0mm max

EFD 15
reinforced insulation
creepage distances: 6mm

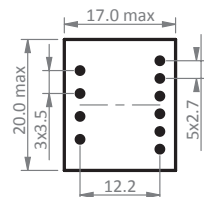
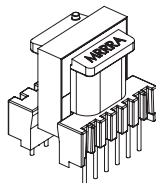

Height : 21.0 mm max

E 16
reinforced insulation
creepage distances: 6mm

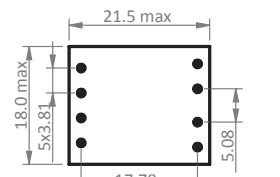
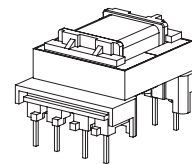

Height : 14.0mm max

EF 16
reinforced insulation
creepage distances: 6mm

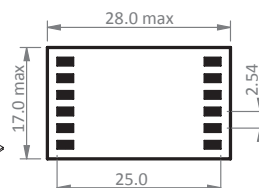
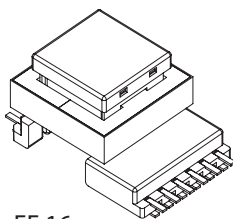

Height : 14.7mm max

EF 16
reinforced insulation
creepage distances: 6mm

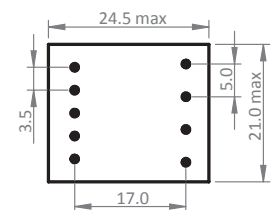
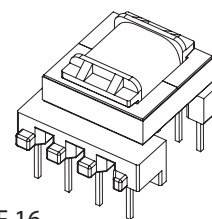

Height : 17mm max

EF 16
reinforced insulation
creepage distances: 6mm

HIGH FREQUENCY FERRITE
POWER FERRITE TRANSFORMERS

*non-exhaustive list



20W

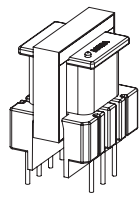

E 19
reinforced insulation
creepage distances: 6mm

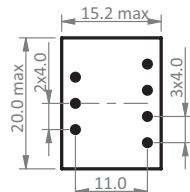

Height : 23.5mm max

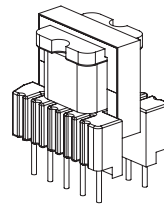

E 19
reinforced insulation
creepage distances: 6mm

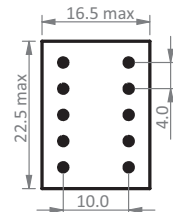

Height : 23.5mm max

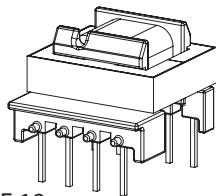

E 19
reinforced insulation
creepage distances: 6mm

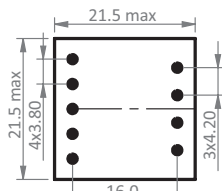

Height : 15.0mm max

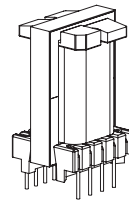

EL 19
reinforced insulation
creepage distances: 6mm

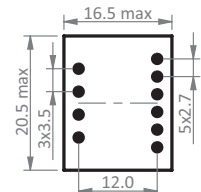

Height : 31.0mm max

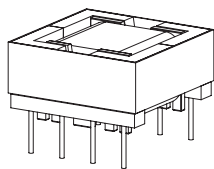

EFD 20
basic insulation

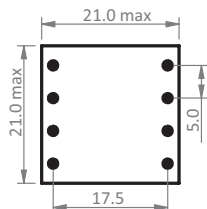

Height : 11.0mm max

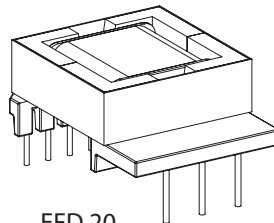

EFD 20
reinforced insulation
creepage distances: 6mm

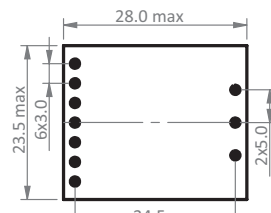

Height : 11.5mm max

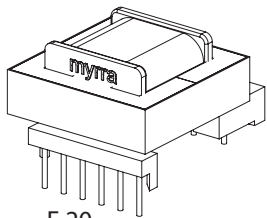

E 20
reinforced insulation
creepage distances: 6mm

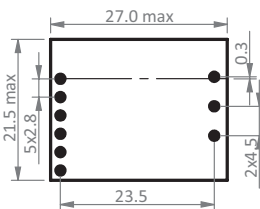

Height : 13.0mm max

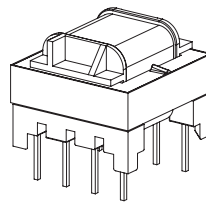

EF 20
basic insulation

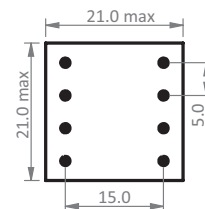

Height : 16.0mm max

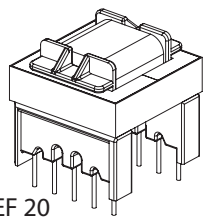

EF 20
reinforced insulation
creepage distances: 6mm

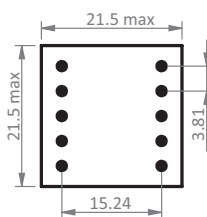

Height : 21.0mm max

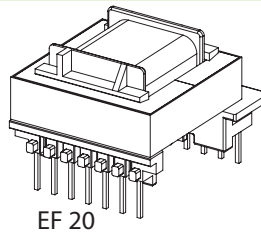

EF 20
reinforced insulation
creepage distances: 8mm

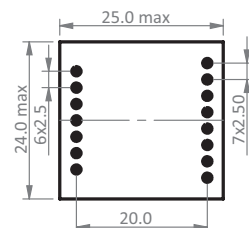

Height : 16.0mm max

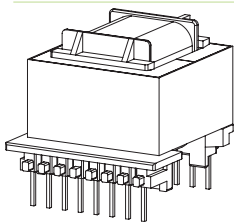

EF 20/11
reinforced insulation
creepage distances: 6mm

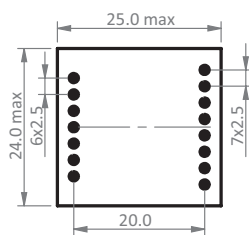

Height : 22.0mm max

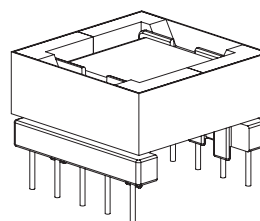

EFD 25
basic insulation

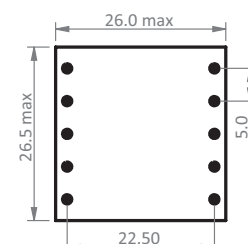

Height : 16.0mm max

HIGH FREQUENCY FERRITE
POWER FERRITE TRANSFORMERS

*non-exhaustive list

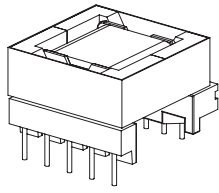

EFD 25
reinforced insulation
creepage distances: 6mm

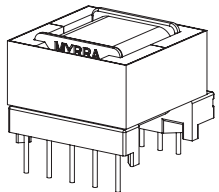
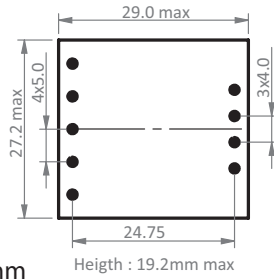

EVD 25
reinforced insulation
creepage distances: 6mm

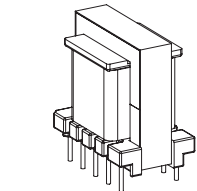
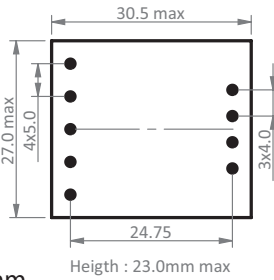

EF 25
reinforced insulation
creepage distances: 6mm

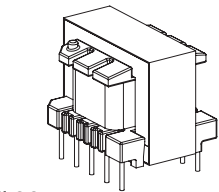
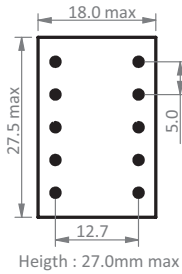

EI 28
reinforced insulation
creepage distances: 6mm

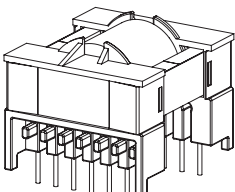
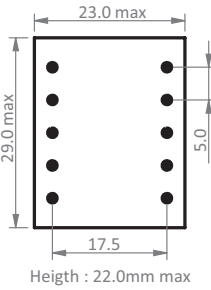

ETD Horizontal
reinforced insulation
creepage distances: 6mm

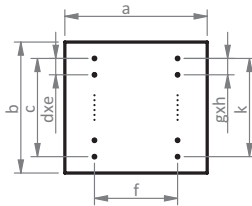

unit:mm

| Size | Pin Qty. | a (max) | b (max) | c | dx | e | gx | h | k | height (max) |
|-------|----------|---------|---------|-------|--------|-------|--------|-------|------|--------------|
| ETD29 | 7+7 | 36.5 | 36.5 | 30.48 | 6x5.08 | 25.4 | 6x5.08 | 30.48 | 25.5 | |
| ETD34 | 7+7 | 43.0 | 41.0 | 30.0 | 6x5.0 | 25.5 | 6x5.0 | 30.0 | 34.5 | |
| ETD39 | 8+8 | 45.0 | 45.0 | 35.0 | 7x5.0 | 30.2 | 7x5.0 | 35.0 | 34.0 | |
| ETD44 | 9+9 | 52.5 | 50.0 | 40.0 | 8x5.0 | 35.56 | 8x5.0 | 40.0 | 40.0 | |
| ETD49 | 10+10 | 58.0 | 57.0 | 45.0 | 9x5.0 | 40.8 | 9x5.0 | 45.0 | 43.5 | |

50W

100W

200W

500W

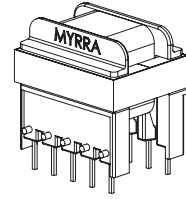

E 25
reinforced insulation
creepage distances: 8mm

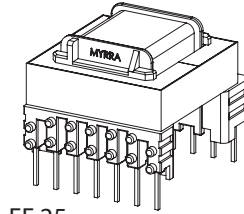
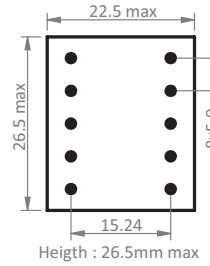

EF 25
reinforced insulation
creepage distances: 8mm

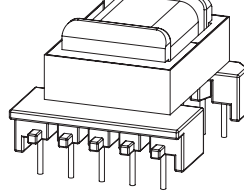
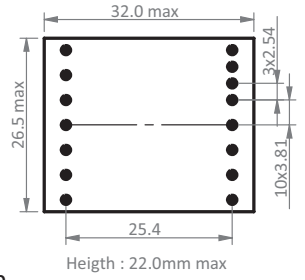

EF 25
reinforced insulation
creepage distances: 6mm

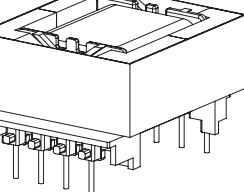
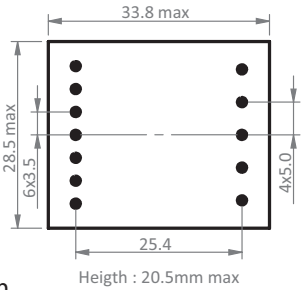

EVD 30
reinforced insulation
creepage distances: 6mm

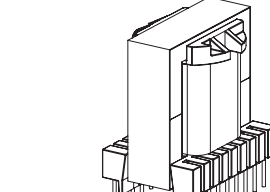
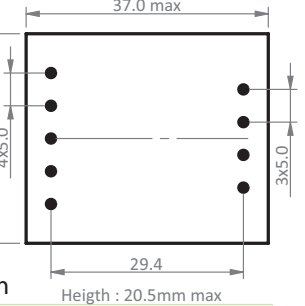

ETD Vertical
reinforced insulation
creepage distances: 6mm

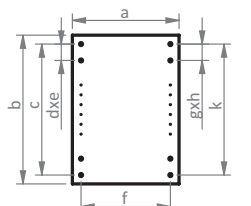

unit:mm

| Size | Pin Qty. | a (max) | b (max) | c | dx | e | gx | h | k | height (max) |
|-------|----------|---------|---------|-------|---------|-------|---------|-------|------|--------------|
| ETD29 | 7+7 | 25.0 | 35.5 | 30.48 | 6x5.08 | 20.32 | 6x5.08 | 30.48 | 41.5 | |
| ETD34 | 7+7 | 28.0 | 35.5 | 30.48 | 6x5.08 | 22.85 | 6x5.08 | 30.48 | 35.5 | |
| ETD39 | 8+8 | 31.5 | 41.0 | 35.0 | 7x5.0 | 25.4 | 7x5.0 | 35.0 | 47.0 | |
| ETD44 | 9+9 | 33.5 | 46.0 | 40.0 | 8x5.0 | 27.5 | 8x5.0 | 40.0 | 51.0 | |
| ETD49 | 11+11 | 50.0 | 68.2 | 50.8 | 10x5.08 | 33.02 | 10x5.08 | 50.8 | 72.5 | |

HIGH FREQUENCY FERRITE
POWER FERRITE TRANSFORMERS

*non-exhaustive list

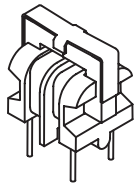

U9.8

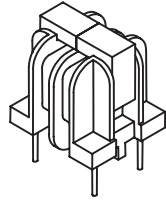

U10.5

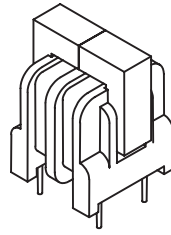

U16

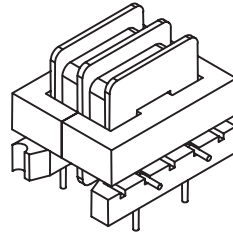

E25

- Mainly used to reduce noise conducted through power or signal lines.
- The common mode inductance filters symmetrical noise, associated with Y-type safety capacitors connected to ground.
- The differential mode inductance filters asymmetrical noise, associated with X-type capacitor connected between Line and Neutral.

| MYRRA Part N° | SIZE | Inductance range | Current range |
|----------------------|-------|------------------|---------------|
| 74330 - 74339 | U9.8 | 1.5 to 47mH | 0.18 to 1.1A |
| 74300 - 74306 | U10.5 | 1.5 to 68mH | 0.30 to 1.9A |
| 74310 - 74315 | U16 | 1.5 to 33mH | 0.75 to 3.3A |
| 74320 - 74325 | E25 | 1.5 to 33mH | 0.90 to 4.0A |

- **Toroidal Common Mode Chokes - Custom design available upon request**

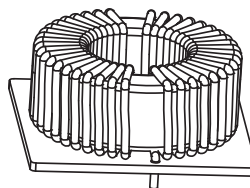
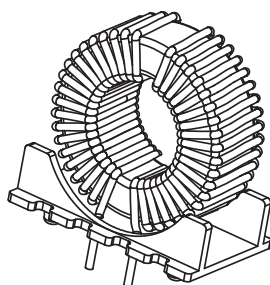



- Ambient Temperature $\leq 50^{\circ}\text{C}$
- Dielectric Strength $\geq 1.5\text{ kV}$ between windings
- Electrical characteristics at 25°C

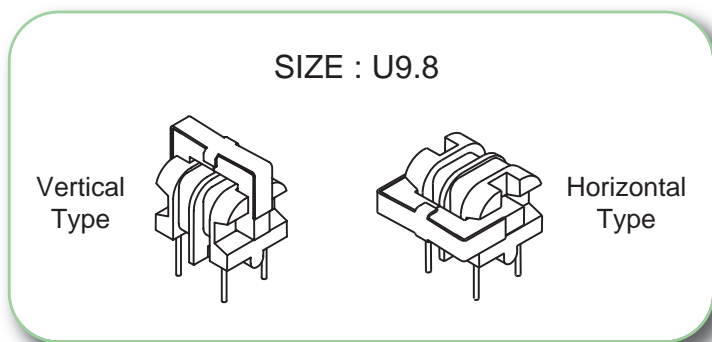

ELECTRICAL CHARACTERISTICS :

| MYRRA Part N° | | Inductance Common Mode min - max (mH) | Rated Current Arms | Resistance per winding ohm max | Inductance Differential Mode μH min | Resonant Frequency kHz min |
|---------------|-----------------|---------------------------------------|--------------------|--------------------------------|--|----------------------------|
| Vertical Type | Horizontal Type | | | | | |
| 74330 | 74335 | 33 - 56 | 0.18 | 7 | 710 | 210 |
| 74331 | 74336 | 18 - 31 | 0.26 | 3.5 | 360 | 280 |
| 74332 | 74337 | 10 - 17 | 0.35 | 2.0 | 210 | 400 |
| 74333 | 74338 | 4.7 - 8 | 0.5 | .95 | 100 | 610 |
| 74334 | 74339 | 2.2 - 3.7 | 0.8 | .4 | 45 | 910 |

MECHANICAL CHARACTERISTICS / PINOUT :

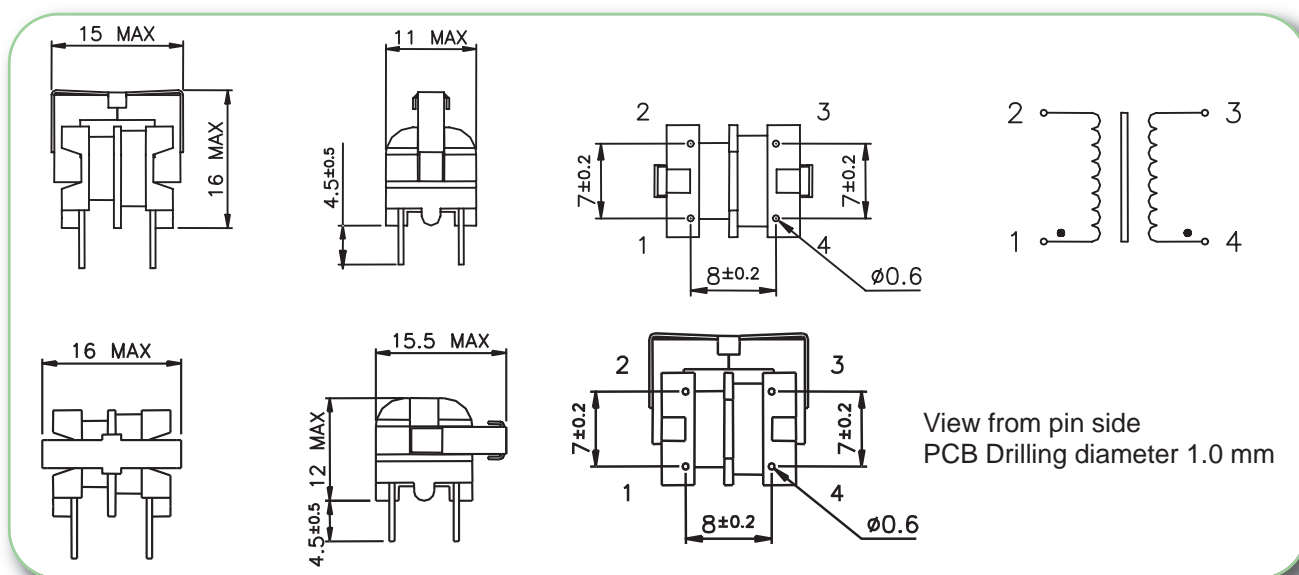

HIGH FREQUENCY FERRITE
CURRENT TRANSFORMERS RANGE



- Ambient Temperature $\leq 50^{\circ}\text{C}$
- Dielectric Strength ≥ 1.5 kV between windings
- Electrical characteristics at 25°C

SIZE : U10.5

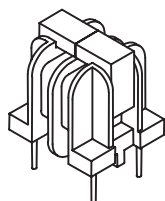

ELECTRICAL CHARACTERISTICS :

| MYRRA Part N° | Inductance Common Mode min - max (mH) | Rated Current Arms | Resistance per winding ohm max | Inductance Differential Mode μH min | Resonant Frequency kHz min |
|---------------|---------------------------------------|--------------------|--------------------------------|--|----------------------------|
| 74306 | 51 - 85 | 0.3 | 4 | 530 | 125 |
| 74300 | 33 - 56 | 0,35 | 3 | 400 | 170 |
| 74301 | 18 - 31 | 0,45 | 1,7 | 240 | 220 |
| 74302 | 10 - 17 | 0,6 | 1 | 140 | 320 |
| 74303 | 4.7 - 8 | 0,9 | 0,43 | 65 | 480 |
| 74304 | 2.2 - 3.7 | 1,3 | 0,23 | 32 | 740 |
| 74305 | 1 - 1.7 | 1,9 | 0,1 | 14 | 1000 |

MECHANICAL CHARACTERISTICS / PINOUT :

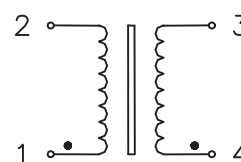
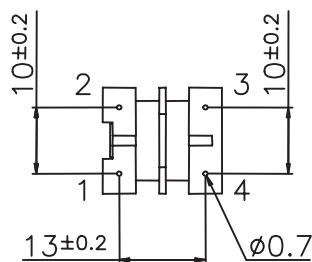
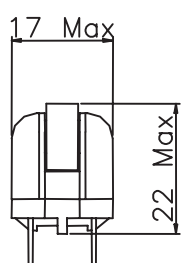
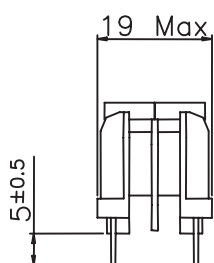

View from pin side
PCB Drilling diameter 1.1 mm

HIGH FREQUENCY FERRITE
CURRENT TRANSFORMERS RANGE



- Ambient Temperature $\leq 50^{\circ}\text{C}$
- Dielectric Strength $\geq 1.5\text{ kV}$ between windings
- Electrical characteristics at 25°C

SIZE : U16

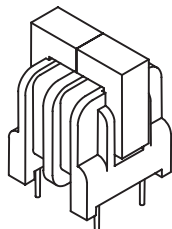

ELECTRICAL CHARACTERISTICS :

| MYRRA Part N° | Inductance Common Mode min - max (mH) | Rated Current Arms | Resistance per winding ohm max | Inductance Differential Mode μH min | Resonant Frequency kHz min |
|---------------|---------------------------------------|--------------------|--------------------------------|--|----------------------------|
| 74310 | 22 - 37 | 0,75 | 1 | 230 | 170 |
| 74311 | 15 - 25 | 0,9 | 0,75 | 150 | 210 |
| 74312 | 10 - 17 | 1,1 | 0,44 | 100 | 280 |
| 74313 | 4.7 - 8 | 1,5 | 0,24 | 50 | 440 |
| 74314 | 2.2 - 3.7 | 2,3 | 0,095 | 20 | 650 |
| 74315 | 1 - 1.7 | 3,3 | 0,046 | 10 | 1000 |

MECHANICAL CHARACTERISTICS / PINOUT :

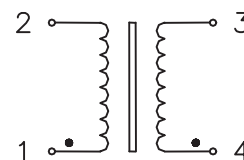
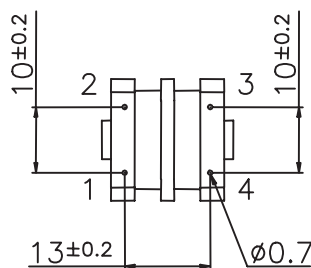
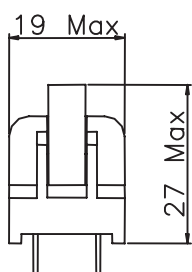
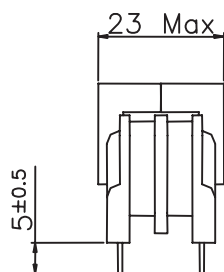

View from pin side
PCB Drilling diameter 1.1 mm

HIGH FREQUENCY FERRITE
CURRENT TRANSFORMERS RANGE



- Ambient Temperature $\leq 50^{\circ}\text{C}$
- Dielectric Strength $\geq 1.5\text{ kV}$ between windings
- Electrical characteristics at 25°C

SIZE : E25

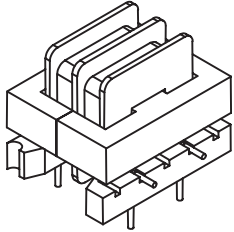

ELECTRICAL CHARACTERISTICS :

| MYRRA Part N° | Inductance Common Mode min - max (mH) | Rated Current Arms | Resistance per winding ohm max | Inductance Differential Mode μH min | Resonant Frequency kHz min |
|---------------|---------------------------------------|--------------------|--------------------------------|--|----------------------------|
| 74320 | 22 – 37 | 0,9 | 0,54 | 130 | 170 |
| 74321 | 15 – 25 | 1,1 | 0,35 | 90 | 210 |
| 74322 | 10 - 17 | 1,3 | 0,22 | 50 | 270 |
| 74323 | 4.7 - 8 | 1,8 | 0,105 | 25 | 400 |
| 74324 | 2.2 - 3.7 | 2,7 | 0,05 | 11 | 630 |
| 74325 | 1 - 1.7 | 4 | 0,03 | 7 | 950 |

MECHANICAL CHARACTERISTICS / PINOUT :

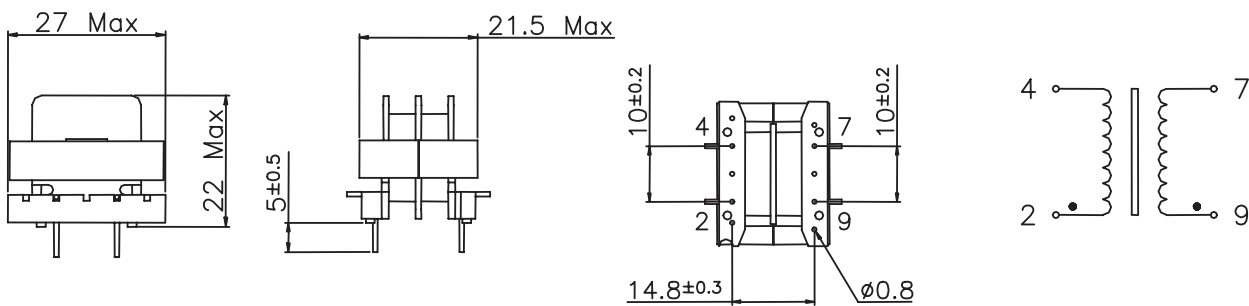

View from pin side
PCB Drilling diameter 1.2 mm

HIGH FREQUENCY FERRITE
CURRENT TRANSFORMERS RANGE



- For noise suppression in light dimmers
- Saturable chokes : provides a high impedance for Triac switching interferences, and a low impedance for 50Hz component.
- Electrical characteristics at 25 °

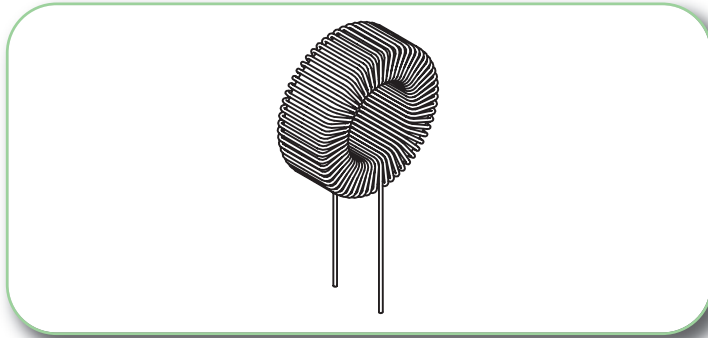

ELECTRICAL CHARACTERISTICS :

| MYRRA Part N° | Power | Inductance +/- 15 % | Rated Current | Resistance | Associated Capacitor | Dimensions (mm) | | | | Approx. Weight |
|---------------|--------|---------------------|---------------|------------|----------------------|-----------------|--------|-------|-------|----------------|
| | | | | | | OD max | ID min | H max | W max | |
| 74190 | 150 w | 3.5 mH | 0.7 Arms | 1.5 Ω | 22 nF | 24 | 9 | 9.5 | 0.5 | 13 g |
| 74191 | 300 w | 2.8 mH | 1.3 Arms | 0.73 Ω | 47 nF | 29 | 10 | 12 | 0.7 | 24 g |
| 74192 | 500 w | 2.0 mH | 2.2 Arms | 0.35 Ω | 82 nF | 32.5 | 9 | 16 | 0.9 | 47 g |
| 74196 | 500 w | 1.8 mH | 2.2 Arms | 0.37 Ω | 82 nF | 38 | 14 | 12 | 0.9 | 39 g |
| 74193 | 1000 w | 1.3 mH | 4.5 Arms | 0.15 Ω | 220 nF | 44 | 14 | 16.5 | 1.2 | 80 g |
| 74194 | 2200 w | 450 μH | 10 Arms | 0.04 Ω | 470 nF | 50 | 12 | 22.5 | 1.8 | 140 g |
| 74195 | 4500 w | 250 μH | 20 Arms | 0.014 Ω | 1 μF | 58 | 10 | 28 | 2.5 | 250 g |

MECHANICAL CHARACTERISTICS :

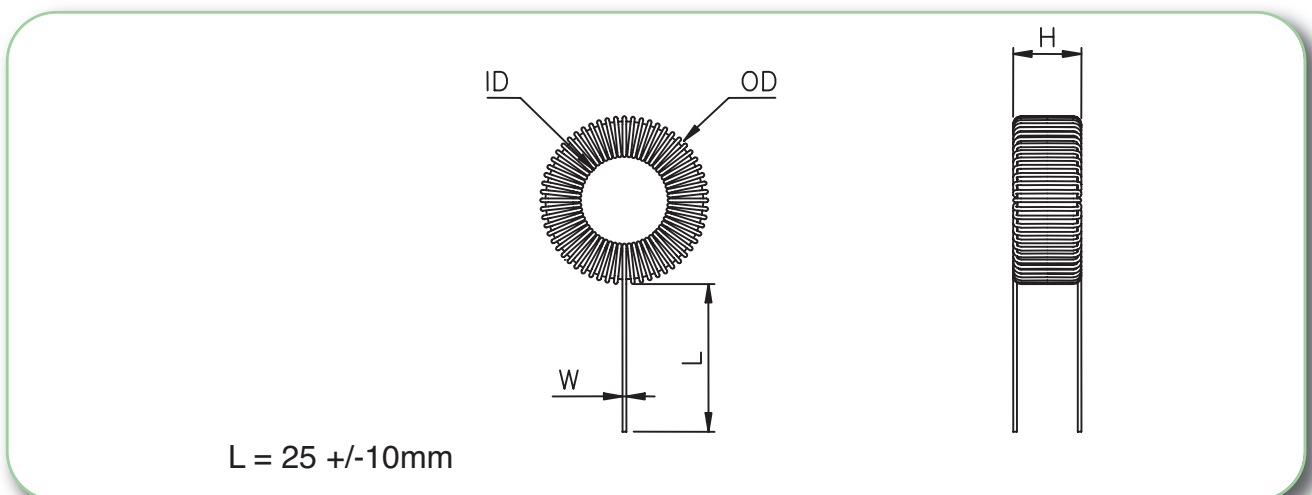

HIGH FREQUENCY FERRITE TOROIDAL CHOKES

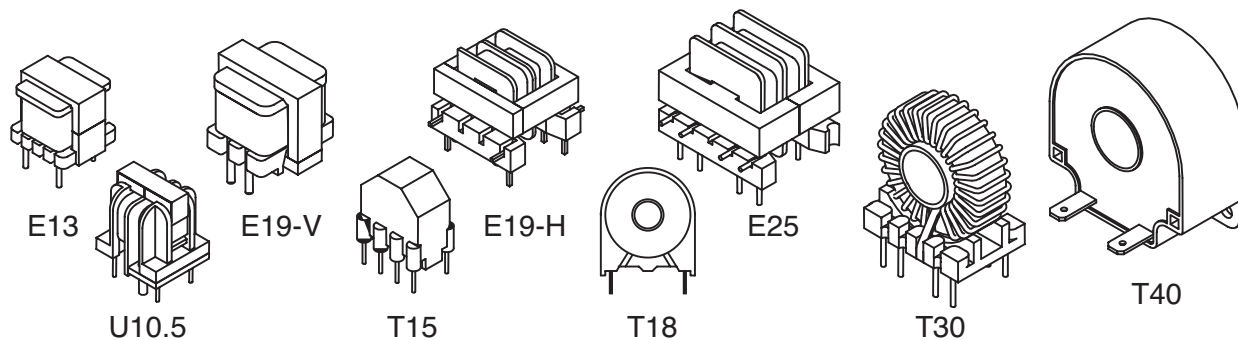

• FOR MAINS AC CURRENT MEASUREMENT - 50 to 400 Hz

| MYRRA Part N° | SIZE | Ratio | Current range |
|---------------------------------------|------------|--------------------|-----------------------|
| PIN PRIMARY - up to 25A | | | |
| 74521 | Size E19-H | Ratio 1 / 1 / 750 | Current 10 A / 20 A |
| 74523 | Size E19-V | Ratio 1 / 500 | Current 15 A |
| 74531 | Size E25 | Ratio 1 / 1 / 1000 | Current 12.5 A / 25 A |
| 74533 | Size E25 | Ratio 1 / 1000 | Current 8 A |
| 74534 | Size E25 | Ratio 1 / 350 | Current 4 A |
| 74561 | Size U10.5 | Ratio 1 / 2000 | Current 8 A |
| THRU-HOLE PRIMARY - up to 250A | | | |
| 74503 | Size T18 | Ratio 1 / 1000 | Current 12 A |
| 74504 | Size T18 | Ratio 1 / 750 | Current 10 A |
| 74511 | Size T30 | Ratio 1 / 1000 | Current 60 A |
| 74543, 74544, 74545 | Size T40 | Ratio 1 / 500 | Current 100 A |
| 74546, 74547, 74548 | Size T40 | Ratio 1 / 1000 | Current 250 A |

• FOR SWITCH MODE POWER SUPPLIES - 20 to 150kHz

| MYRRA Part N° | SIZE | Ratio | Current range |
|---------------------------------------|------------|-------------------|-----------------------|
| PIN PRIMARY - up to 25A | | | |
| 74520 | Size E19-H | Ratio 1 / 1 / 100 | Current 10 A / 20 A |
| 74530 | Size E25 | Ratio 1 / 1 / 100 | Current 12.5 A / 25 A |
| 74550 | Size E13 | Ratio 1 / 100 | Current 10 A |
| 74560 | Size U10.5 | Ratio 1 / 100 | Current 10 A |
| 74562 | Size U10.5 | Ratio 1 / 100 | Current 10 A |
| 74570 | Size T15 | Ratio 1 / 1 / 50 | Current 10 A / 20 A |
| THRU-HOLE PRIMARY - up to 200A | | | |
| 74500 | Size T18 | Ratio 1 / 50 | Current 15 A |
| 74501 | Size T18 | Ratio 1 / 100 | Current 25 A |
| 74502 | Size T18 | Ratio 1 / 200 | Current 25 A |
| 74510 | Size T30 | Ratio 1 / 100 | Current 150 A |
| 74540, 74541, 74542 | Size T40 | Ratio 1 / 100 | Current 200 A |

HIGH FREQUENCY FERRITE
CURRENT TRANSFORMERS RANGE

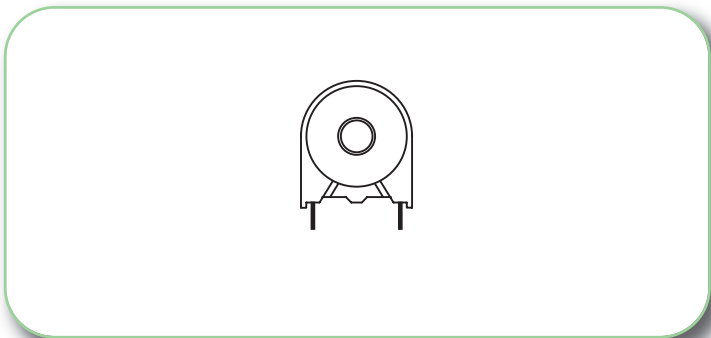

| MYRRA Part N° | Sec. Turns | Max Pri. Current A rms | Rsec. Ω max | Lsec. mH min | Pulse Vsec x t max @ Frequency | Sine Vsec max @ Frequency | Typical Load/ Accuracy/ Current |
|---------------|------------|------------------------|--------------------|--------------|--------------------------------|--------------------------------------|---|
| 74500 | 50 | 15 A | 0.6 Ω | 5 | 175 V μ S 20 – 200 kHz | 15 V 20 – 200 kHz | 50 Ω / 1% / 15 A |
| 74501 | 100 | 25 A | 1.5 Ω | 20 | 350 V μ S 20 – 100 kHz | 25 V 20 – 100 kHz | 100 Ω / 1% / 25 A |
| 74502 | 200 | 25 A | 5 Ω | 80 | 700 V μ S 20 – 100 kHz | 50 V 20 – 100 kHz | 200 Ω / 1% / 25 A |
| 74503 | 1000 | 12 A | 45 Ω | 2000 | 2.5 V.ms 50 Hz | 0.15V/ 50 Hz/ 12A 0.6V/ 50 Hz/ 8A | $\leq 10 \Omega$ / 2% / 12 A $\leq 40 \Omega$ / 2% / 8 A |
| 74504 | 750 | 10 A | 35 Ω | 1100 | 2.0 V.ms 50 Hz | 0.13V/ 50 Hz/ 10A 0.3V/ 50 Hz/ 5A | $\leq 10 \Omega$ / 2% / 10 A $\leq 40 \Omega$ / 2% / 5 A |

Data applies for one primary turn (single passage of primary wire through toroid hole). Sensitivity can be increased for lower currents by winding more than one turn.

HIGH FREQUENCY FERRITE
CURRENT TRANSFORMERS RANGE

**74500 / 74501 / 74502
74503 / 74504**

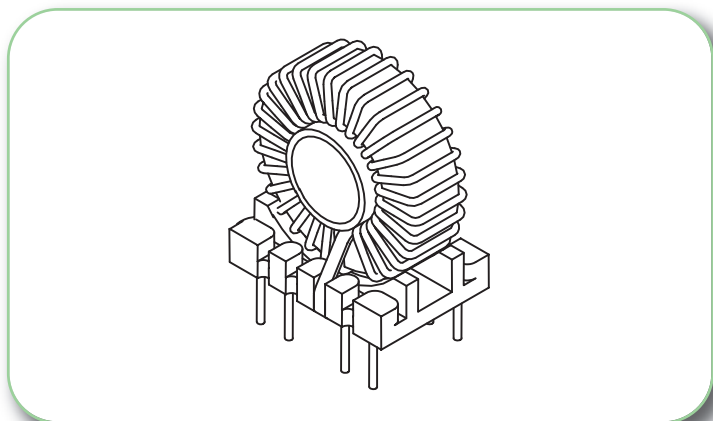

| MYRRA Part N° | Sec. Turns | Max Pri. Current Arms | Rsec. Ω max | Lsec. mH min | Pulse Vsec x t max @ Frequency | Sine Vsec max @ Frequency | Typical Load/Accuracy/ Current |
|---------------|------------|-----------------------|-------------|--------------|--|--|--|
| 74510 | 100 | 150 A | 0.25Ω | 40 | 1 V.ms/ 20 kHz 700 V μs/ 100 kHz | 50 V/ 20 kHz 80 V/ 100 kHz | 1 - 20 Ω / 1% |
| 74511 | 1000 | 60 A | 32 Ω | 4000 | 10 V.ms/ 50 Hz | 0.6 V/ 50 Hz/ 60 A 1 V/ 50 Hz/ 40 A | ≤ 10 Ω / 1% / 60 A ≤ 20 Ω / 1% / 40 A |

Data applies for one primary turn (single passage of primary wire through toroid hole).

Sensitivity can be increased for lower currents by winding more than one turn.

Models with 50, 100, 200 turns are designed for switch-mode power conversion

(up to 200 kHz).

Models with 500 and 1000 turns are designed for Mains current measurement (50 to 400 Hz).

74510/ 74511

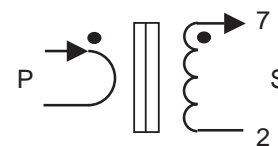
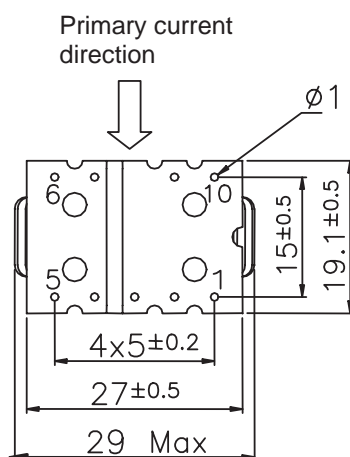
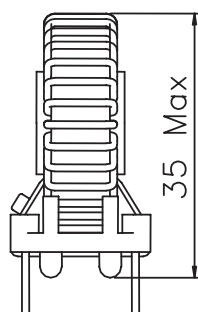
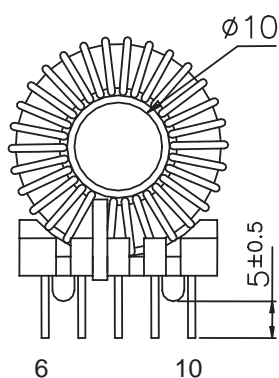

Pin 8 removed for locating

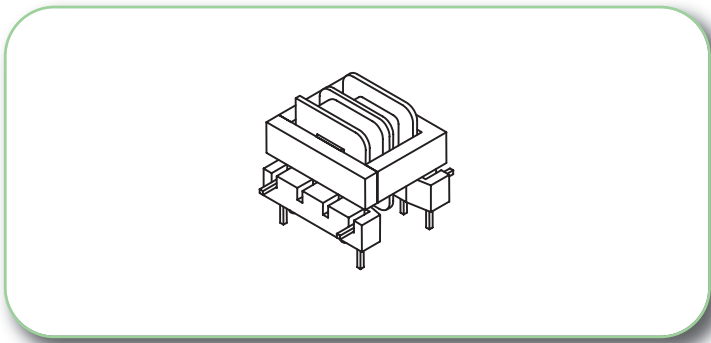

| FOR SWITCH MODE POWER SUPPLIES - 20 to 150 kHz | | | | | | | | |
|--|---------|-----------------------------|-------------|--------------|--------------------|-------------------|---------------------------------|------------------------|
| MYRRA Part N° | Ratio | Max Pri. Current A rms | Rsec. Ω max | Lsec. mH min | Pulse Vsec x t max | Sine Vsec rms max | Typical Load/ Accuracy/ Current | Insulation Voltage P/S |
| 74520 | 1/1/100 | 20 A parallel 10 A serie | 1.5 | 8 | 400 V.µs | 50 Vrms | 10 – 100 Ω / 1% / 10 A | 2500 V |

| FOR MAINS AC CURRENT MEASUREMENT - 50 to 400 Hz | | | | | | | | |
|---|---------|-----------------------------|-------------|--------------|--------------------|-------------------|---------------------------------|------------------------|
| MYRRA Part N° | Ratio | Max Pri. Current A rms | Rsec. Ω max | Lsec. mH min | Pulse Vsec x t max | Sine Vsec rms max | Typical Load/ Accuracy/ Current | Insulation Voltage P/S |
| 74521 | 1/1/750 | 20 A parallel 10 A serie | 57 | 300 | 15 V.ms | 3 Vrms | ≤ 75 Ω / 4% / 20 A | 2500 V |

SAFETY :

These products are only composed of UL approved materials.

These products have a construction conform to CEI950, CEI335, CEI61558 for Basic insulation (3 mm creepage distance)

HIGH FREQUENCY FERRITE
CURRENT TRANSFORMERS RANGE

74520/ 74521

Pins 6 & 7 removed for locating
PCB drill @ Ø 1.3 mm

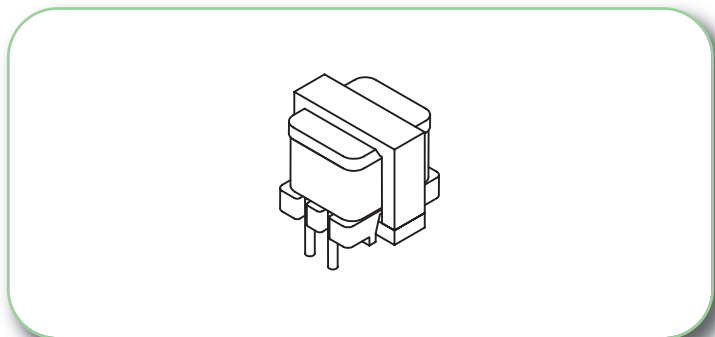

FOR MAINS AC CURRENT MEASUREMENT - 50 to 400 Hz

| MYRRA Part N° | Ratio | Max Pri. Current A rms | Rsec. Ω max | Lsec. mH min | Pulse Vsec x t max | Sine Vsec rms max | Typical Load/ Accuracy/ Current | Insulation Voltage P/ S |
|---------------|--------|------------------------|-------------|--------------|--------------------|-------------------|---|-------------------------|
| 74523 | 1/ 500 | 15 A | 155 | 670 | 30 V.ms | 6 Vrms | ≤ 50 Ω / 2% / 15 A ≤ 200 Ω / 5% / 10 A | 1500 V |

SAFETY :

This product is only composed of UL approved materials.

This product has a construction conform to CEI950, CEI335, CEI61558 for Functional insulation

74523

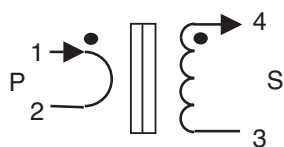

Pins 6 & 7 removed for locating PCB drill @ Ø 1.2 & 1.8 mm

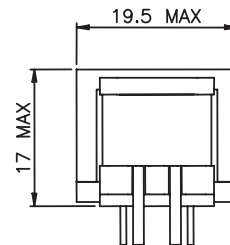
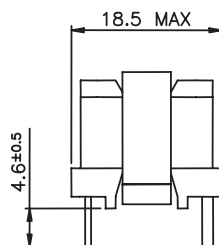
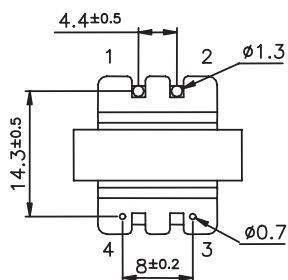

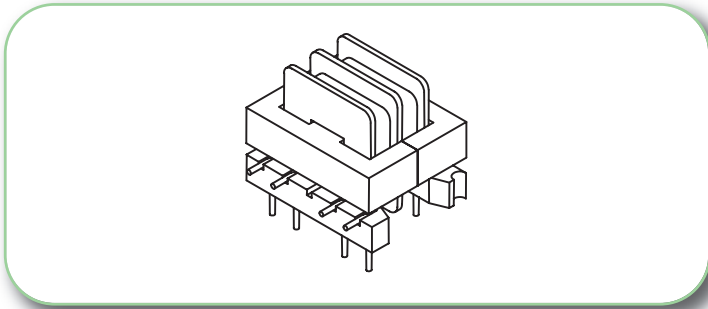

| FOR SWITCH MODE POWER SUPPLIES - 20 to 150 kHz | | | | | | | | |
|--|---------|-------------------------------|-------------|--------------|--------------------|-------------------|---------------------------------|------------------------|
| MYRRA Part N° | Ratio | Max Pri. Current A rms | Rsec. Ω max | Lsec. mH min | Pulse Vsec x t max | Sine Vsec rms max | Typical Load/ Accuracy/ Current | Insulation Voltage P/S |
| 74530 | 1/1/100 | 25 A parallel 12.5 A serie | 1 | 10 | 600 V.µs | 80 Vrms | 10 - 100 Ω / 1% / 25 A | 2500 V |

| FOR MAINS AC CURRENT MEASUREMENT - 50 to 400 Hz | | | | | | | | |
|---|----------|-------------------------------|-------------|--------------|--------------------|-------------------|--|------------------------|
| MYRRA Part N° | Ratio | Max Pri. Current A rms | Rsec. Ω max | Lsec. mH min | Pulse Vsec x t max | Sine Vsec rms max | Typical Load/ Accuracy/ Current | Insulation Voltage P/S |
| 74531 | 1/1/1000 | 25 A parallel 12.5 A serie | 90 | 4 H | 8 V.ms | 1.6 Vrms | ≤ 50 Ω / 2% / 20 A | 2500 V |
| 74533 | 1/ 1000 | 8 A | 360 | 17 H | 15 V.ms | 3 Vrms | ≤ 200 Ω / 1% / 8 A ≤ 500 Ω / 1.5% / 5 A | 2500 V |
| 74534 | 1/350 | 4 A | 380 | 19 H | 15 V.ms | 3 Vrms | ≤ 100 Ω / 1% / 4 A ≤ 500 Ω / 1% / 2 A | 2500 V |

SAFETY :

These products are only composed of UL approved materials.

These products have a construction conform to CEI950, CEI335, CEI61558 for Basic insulation (3 mm creepage distance)

HIGH FREQUENCY FERRITE
CURRENT TRANSFORMERS RANGE

74530/ 74531

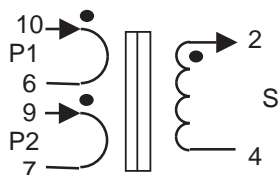

74533/ 74534

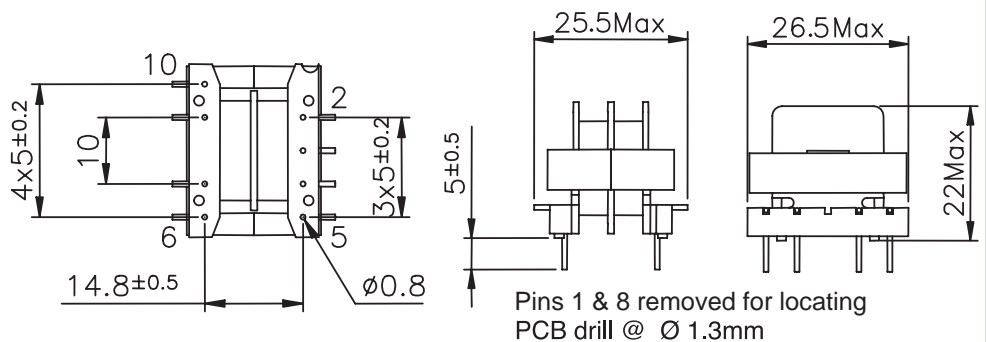
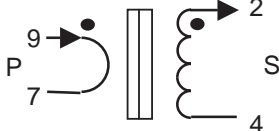

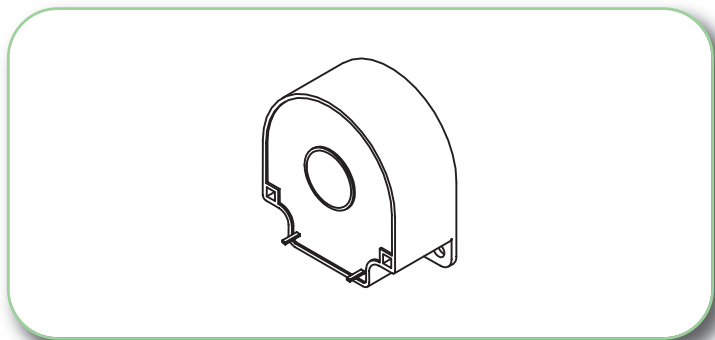

| MYRRA Part N° | Sec. Turns | Max Pri. Current A rms | Rsec. Ω max | Lsec. mH min | Pulse Vsec x t max @ Frequency | Sine Vsec max @ Frequency | Typical Load/ Accuracy/ Current |
|---------------|------------|------------------------|--------------------|--------------|-----------------------------------|---|--|
| 74540 | 100 | 200 A | 0.35 Ω | 50 | 2 V.ms/ 20 kHz 1 V.ms/ 100 kHz | 150 V/ 20 kHz 150 V/ 100 kHz | 1..20 Ω / 1% |
| 74543 | 500 | 100 A | 6.5 Ω | 1250 | 10 V.ms/ 50 Hz | 0.7 V/ 50Hz/ 100 A 1.2 V/ 50Hz/ 60 A | $\leq 3 \Omega$ / 1% / 100 A $\leq 10 \Omega$ / 1% / 60 A |
| 74546 | 1000 | 250 A | 22 Ω | 8000 | 100 V.ms/ 50 Hz | 15 V/ 50 Hz/ 250 A | $\leq 50 \Omega$ / 1% / 250 A |

Data applies for one primary turn (single passage of primary wire through toroid hole). Sensitivity can be increased for lower currents by winding more than one turn.

74540/ 74543/ 74546 Pin type (for PCB) \square 0.6 x 0.95

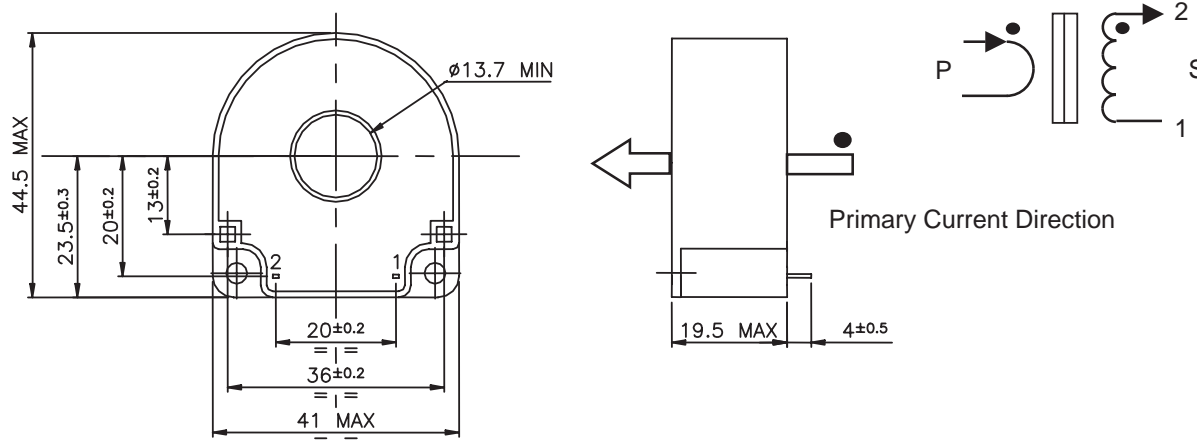

HIGH FREQUENCY FERRITE
CURRENT TRANSFORMERS RANGE

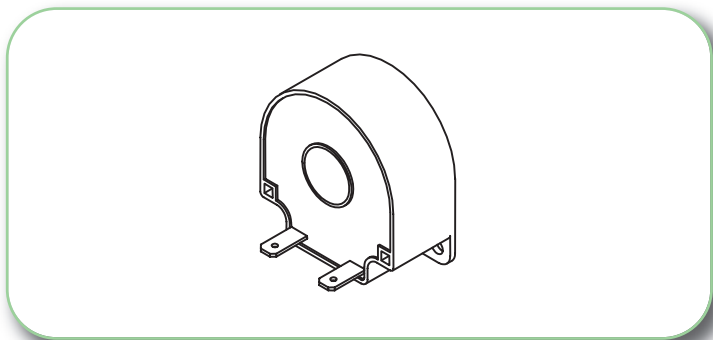

| MYRRA Part N° | Sec. Turns | Max Pri. Current A rms | Rsec. Ω max | Lsec. mH min | Pulse Vsec x t max @ Frequency | Sine Vsec max @ Frequency | Typical Load/ Accuracy/ Current |
|---------------|------------|------------------------|-------------|--------------|-----------------------------------|---|--|
| 74541 | 100 | 200 A | 0.35 Ω | 50 | 2 V.ms/ 20 kHz 1 V.ms/ 100 kHz | 150 V/ 20 kHz 150 V/ 100 kHz | 1.20 Ω / 1% |
| 74544 | 500 | 100 A | 6.5 Ω | 1250 | 10 V.ms/ 50 Hz | 0.7 V/ 50Hz/ 100 A 1.2 V/ 50Hz/ 60 A | ≤ 3 Ω / 1% / 100 A ≤ 10 Ω / 1% / 60 A |
| 74547 | 1000 | 250 A | 22 Ω | 8000 | 100 V.ms/ 50 Hz | 15 V/ 50 Hz/ 250 A | ≤ 50 Ω / 1% / 250 A |

Data applies for one primary turn (single passage of primary wire through toroid hole). Sensitivity can be increased for lower currents by winding more than one turn.

74541/ 74544/ 74547 FASTON Connectors (4.8 x 0.8)

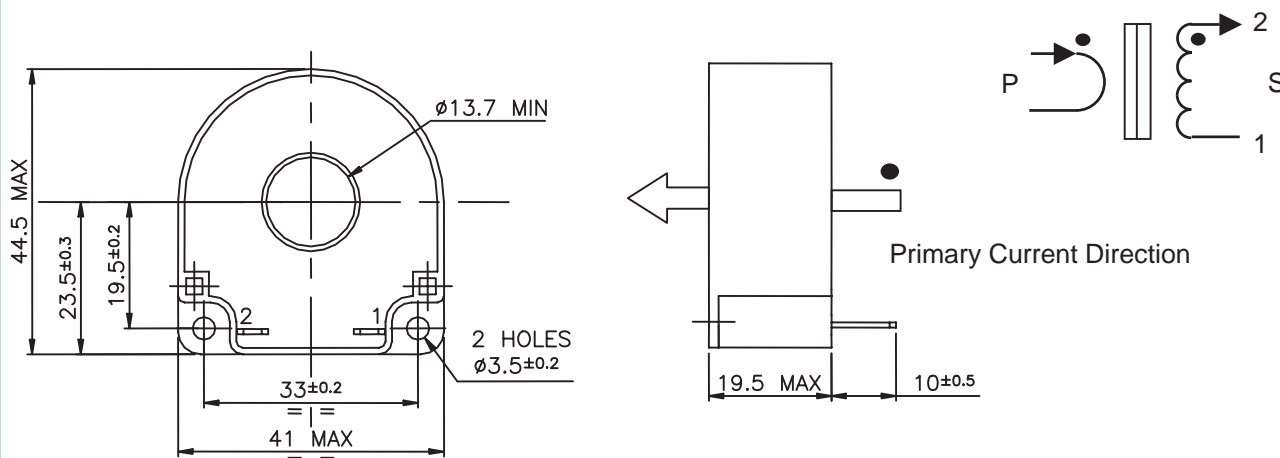

HIGH FREQUENCY FERRITE
CURRENT TRANSFORMERS RANGE

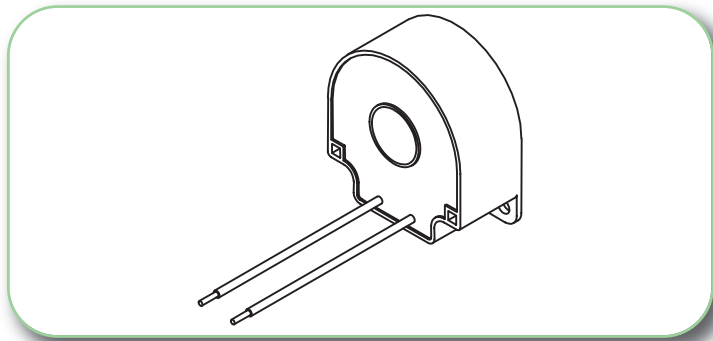

| MYRRA Part N° | Sec. Turns | Max Pri. Current A rms | Rsec. Ω max | Lsec. mH min | Pulse Vsec x t max @ Frequency | Sine Vsec max @ Frequency | Typical Load/ Accuracy/ Current |
|---------------|------------|------------------------|-------------|--------------|-----------------------------------|---|--|
| 74542 | 100 | 200 A | 0.35 Ω | 50 | 2 V.ms/ 20 kHz 1 V.ms/ 100 kHz | 150 V/ 20 kHz 150 V/ 100 kHz | 1..20 Ω / 1% |
| 74545 | 500 | 100 A | 6.5 Ω | 1250 | 10 V.ms/ 50 Hz | 0.7 V/ 50Hz/ 100 A 1.2 V/ 50Hz/ 60 A | ≤ 3 Ω / 1% / 100 A ≤ 10 Ω / 1% / 60 A |
| 74548 | 1000 | 250 A | 22 Ω | 8000 | 100 V.ms/ 50 Hz | 15 V/ 50 Hz/ 250 A | ≤ 50 Ω / 1% / 250 A |

Data applies for one primary turn (single passage of primary wire through toroid hole).
Sensitivity can be increased for lower currents by winding more than one turn.

74542/ 74545/ 74548 Wires type

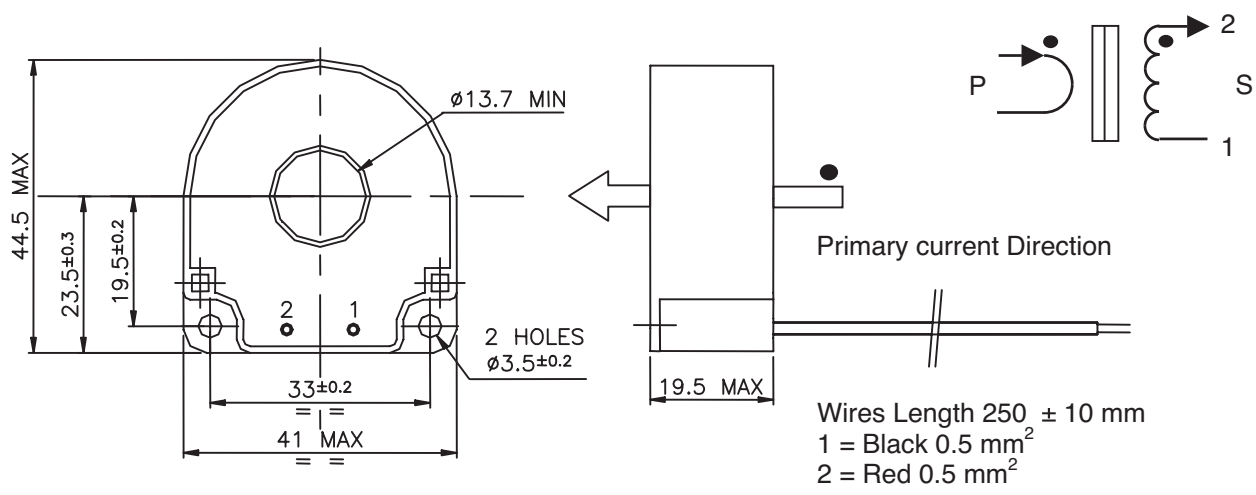

HIGH FREQUENCY FERRITE
CURRENT TRANSFORMERS RANGE

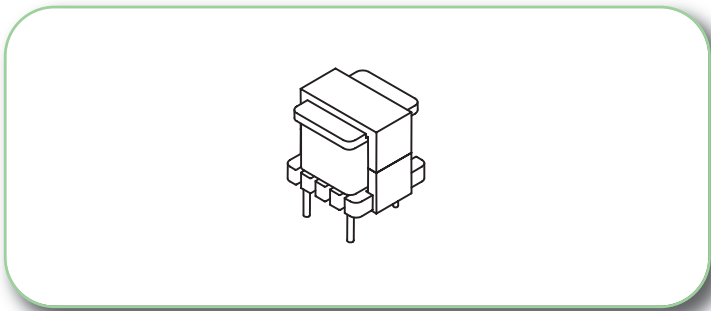

| FOR SWITCH MODE POWER SUPPLIES - 20 to 150 kHz | | | | | | | | |
|--|-------|------------------------|-------------|--------------|--------------------|-------------------|---------------------------------|------------------------|
| MYRRA Part N° | Ratio | Max Pri. Current A rms | Rsec. Ω max | Lsec. mH min | Pulse Vsec x t max | Sine Vsec rms max | Typical Load/ Accuracy/ Current | Insulation Voltage P/S |
| 74550 | 1/100 | 10 | 2.3 | 6 | 250 V.µs | 40 Vrms | 10 – 100 Ω / 1% / 10 A | 1500 V |

SAFETY :

This product is only composed of UL approved materials.

This product has a construction conform to CEI950, CEI335, CEI61558 for functional insulation

74550

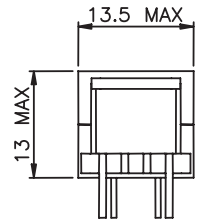
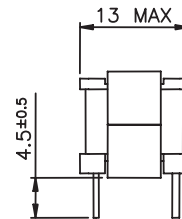
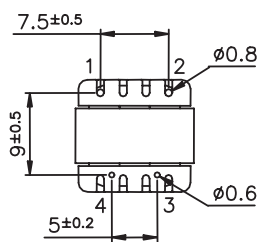
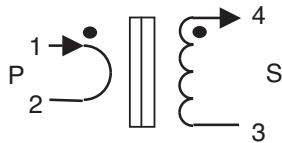

PCB drill @ Ø 1 & 1.3 mm

HIGH FREQUENCY FERRITE
CURRENT TRANSFORMERS RANGE

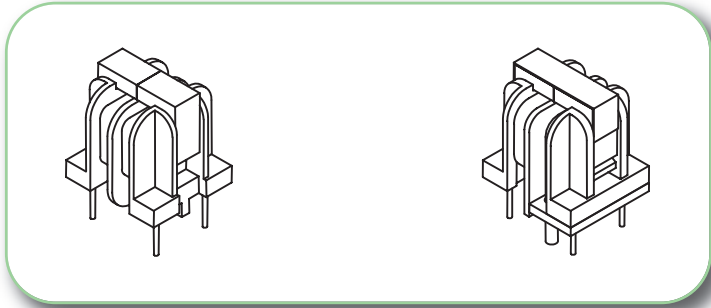

FOR SWITCH MODE POWER SUPPLIES - 20 to 150 kHz

| MYRRA Part N° | Ratio | Max Pri. Current A rms | Rsec. Ω max | Lsec. mH min | Pulse Vsec x t max | Sine Vsec rms max | Typical Load/ Accuracy/ Current | Insulation Voltage P/S |
|---------------|-------|------------------------|-------------|--------------|--------------------|-------------------|---------------------------------|------------------------|
| 74560 | 1/100 | 10 | 1.1 | 12 | 300 V.µs | 25 Vrms | 5 – 50 Ω / 1% / 10 A | 4000 V |
| 74562 | 1/100 | 25 | 1.1 | 12 | 300 V.µs | 25 Vrms | 5 – 50 Ω / 1% / 25 A | 4000 V |

FOR MAINS AC CURRENT MEASUREMENT - 50 to 400 Hz

| MYRRA Part N° | Ratio | Max Pri. Current A rms | Rsec. Ω max | Lsec. mH min | Pulse Vsec x t max | Sine Vsec rms max | Typical Load/ Accuracy/ Current | Insulation Voltage P/S |
|---------------|--------|------------------------|-------------|--------------|--------------------|-------------------|---------------------------------|------------------------|
| 74561 | 1/2000 | 8 A | 400 | 4.5 H | 5 V.ms | 1 Vrms | ≤ 100 Ω / 2% / 6 A | 4000 V |

SAFETY :

These products are only composed of UL approved materials.

These products have a construction conform to CEI950, CEI335, CEI61558 for Reinforced insulation

74560, 74561 : 8 mm creepage distance

74562 : 6 mm creepage distance

74560/ 74561

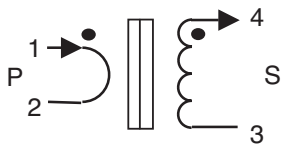

PCB drill @ Ø 1.1 & 2.2 mm

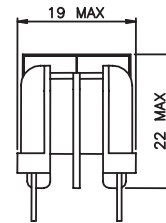
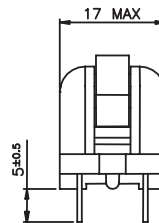
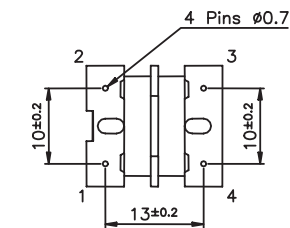

74562

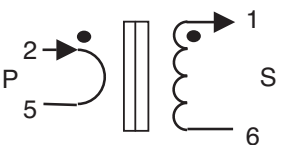

PCB drill @ Ø 1.1 & 2.2 mm

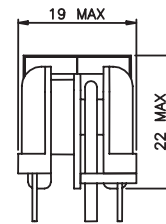
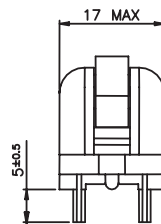
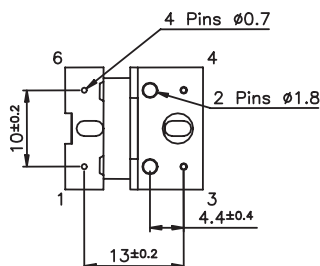

HIGH FREQUENCY FERRITE
CURRENT TRANSFORMERS RANGE

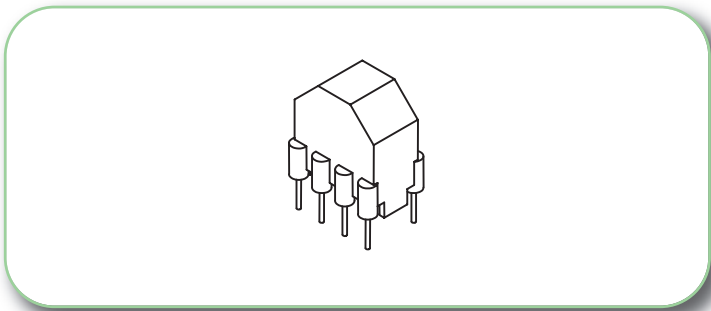

| FOR SWITCH MODE POWER SUPPLIES - 20 to 150 kHz | | | | | | | | |
|--|--------|-----------------------------|-------------|--------------|--------------------|-------------------|---------------------------------|-------------------------|
| MYRRA Part N° | Ratio | Max Pri. Current A rms | Rsec. Ω max | Lsec. mH min | Pulse Vsec x t max | Sine Vsec rms max | Typical Load/ Accuracy/ Current | Insulation Voltage P/ S |
| 74570 | 1/1/50 | 20 A parallel 10 A serie | 0.32 | 9 | 150 V.µs | 12 Vrms | 5 – 25 Ω / 1% / 20 A | 4000 V |

st at myrra.com

SAFETY :

This product is only composed of UL approved materials.
 This product has a construction conform to CEI950, CEI335, CEI61558 for Reinforced insulation (8 mm creepage distance)

74570

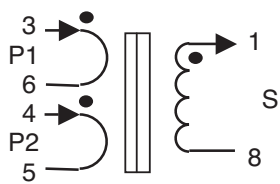

Pins 2 & 7 removed for locating
 PCB drill @ Ø 1.1mm

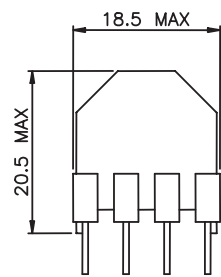
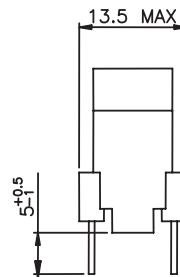
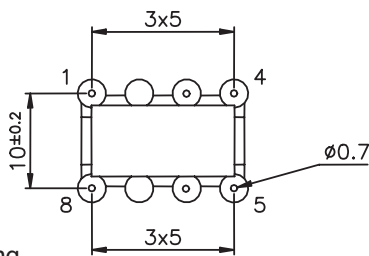

HIGH FREQUENCY FERRITE
 CURRENT TRANSFORMERS RANGE

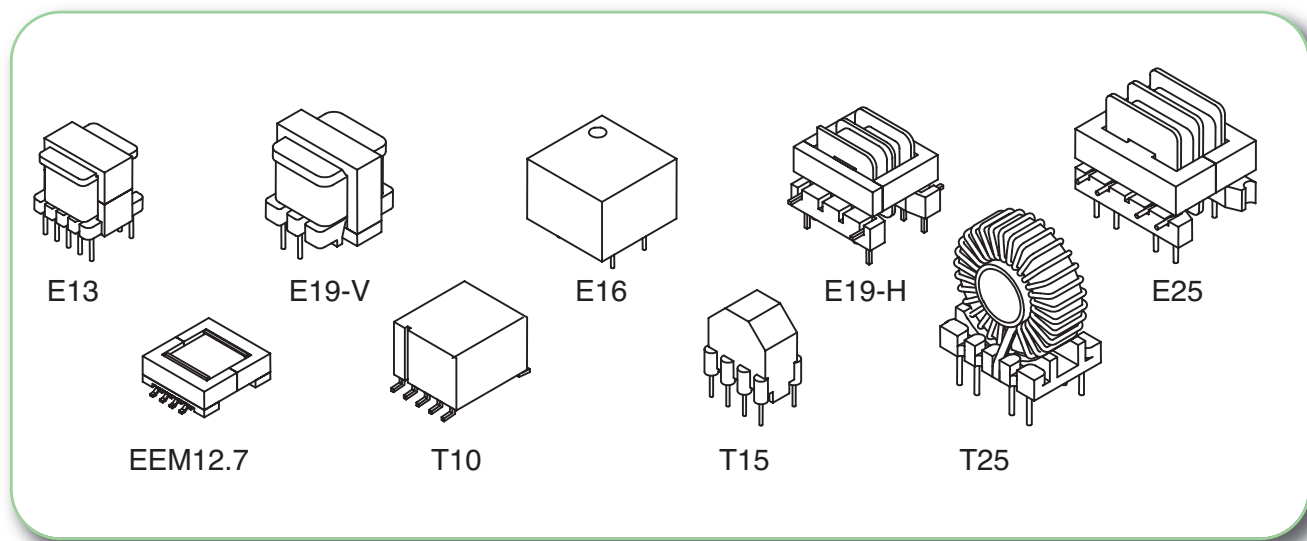

To be used for MOSFET or IGBT Drive, SCR triggering, DC/DC power conversion, Voltage isolation.

| MYRRA Part N° | SIZE | Ratio | |
|---------------|--------------|-------------------|---------------------------|
| 74600 | Size T15 | Ratio 1 / 1 / 1 | Low stray inductance |
| 74610 | Size T25 | Ratio 1 / 1 / 1 | Low stray inductance |
| 74611 | Size T25 | Ratio 1 / 1 / 1 | Low stray inductance |
| 74620 | Size E19-H | Ratio 1 / 1 / 1 | Low coupling capacitance |
| 74621 | Size E19-H | Ratio 3 / 1 / 1 | Low coupling capacitance |
| 74630 | Size E25 | Ratio 1 / 1 / 1 | Low coupling capacitance |
| 74631 | Size E25 | Ratio 3 / 1 / 1 | Low coupling capacitance |
| 74640 | Size E19-V | Ratio 1 / 5 | For voltage step-up |
| 74641 | Size E19-V | Ratio 1 / 10 | For voltage step-up |
| 74650 | Size E13 | Ratio 1 / 1 / 1 | Small size |
| 74710 | Size E16 | Ratio 1 / 1 | Low coupling capacitance |
| 74660 | Size EEM12.7 | Ratio 1CT / 1.3CT | SMD |
| 74661 | Size EEM12.7 | Ratio 1CT / 1CT | SMD, for DC/DC converter |
| 74670 | Size T10 | Ratio 1CT / 1.3 | SMD, Low stray inductance |

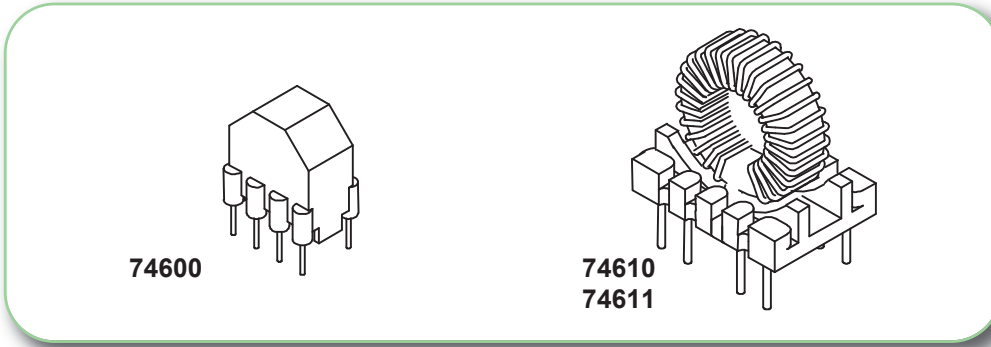

| MYRRA Part N° | Ratio P/S1/S2 | L pri. +/-30% | Current /winding Arms max | Resistance /winding Ω max | Pulse E x t V.µs max | square V / kHz max | C P/S pF max | Lleak P/S max | Insulation Voltage | |
|---------------|---------------|---------------|---------------------------|---------------------------|----------------------|--------------------|--------------|---------------|--------------------|-------|
| | | | | | | | | | P/S | S1/S2 |
| 74600 | 1 / 1 / 1 | 4 – 8 | 0.6 | 0.35 | 150 V.µs | 0.4 | 120 pF | 1.0 µH | 4 kV | 4 kV |
| 74610 | 1 / 1 / 1 | 0.6 – 1.2 | 1.7 | 0.07 | 150 V.µs | 0.4 | 35 pF | 0.6 µH | 4 kV | 4 kV |
| 74611 | 1 / 1 / 1 | 2.5 - 5 | 1.2 | 0.14 | 300 V.µs | 0.8 | 90 pF | 1.2 µH | 4 kV | 4 kV |

- Toroid core gives best coupling, lowest leakage inductance, fast rise time.
- Pulse (E.t rating) is given for bipolar (symmetrical) pulse. Value is reduced for unipolar pulse.

SAFETY :

- These products are only composed of UL-V0 approved materials.
- Insulation test voltage : 4000 Vrms
- This product has a construction conform to CEI950, CEI335, CEI61558 for Reinforced insulation (8 mm creepage distance)

HIGH FREQUENCY FERRITE PULSE TRANSFORMERS

74600 Size T15

Pins 2 & 7 removed for locating

PCB drill @ Ø 1.1mm

Weight ≈ 6 g

74610 - 74611 Size T25

Pin 8 removed for locating

PCB drill @ Ø 1.3mm

Weight ≈ 18 g

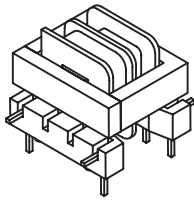

74620
74621

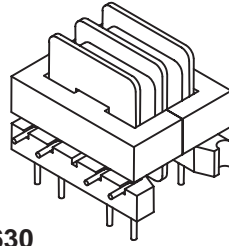

74630
74631

| MYRRA Part N° | Ratio P/S1/S2 | L pri. +/-30% | Current /winding Arms max | Resistance /winding Ω max | Pulse Ext V.µs max | square V / kHz max | C P/S pF max | Leak P/S max | Insulation Voltage | |
|---------------|---------------|---------------|---------------------------|---------------------------|--------------------|--------------------|--------------|--------------|--------------------|--------|
| | | | | | | | | | P/S | S1/S2 |
| 74620 | 1 / 1 / 1 | 3.2 mH | 0.5 | 1.0 | 350 V.µs | 0.6 | 5 pF | 70 µH | 2.5 kV | 1.5 kV |
| 74621 | 3 / 1 / 1 | 17 mH | 0.3 | 2.0 | 800 V.µs | 1.5 | 5 pF | 400 µH | 2.5 kV | 1.5 kV |
| 74630 | 1 / 1 / 1 | 2 mH | 1 | 0.4 | 500 V.µs | 0.8 | 7 pF | 60 µH | 2.5 kV | 1.5 kV |
| 74631 | 3 / 1 / 1 | 10 mH | 0.45 | 0.8 | 1000 V.µs | 1.7 | 7 pF | 300 µH | 2.5 kV | 1.5 kV |

- Principally dedicated to SCR triggering
- Designed for minimum coupling capacitance

SAFETY :

These products are only composed of UL-V0 approved materials.

74620 - 74621 Size E19-H

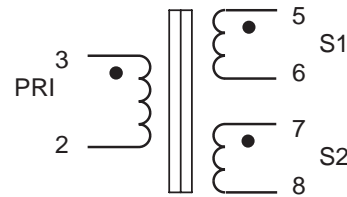
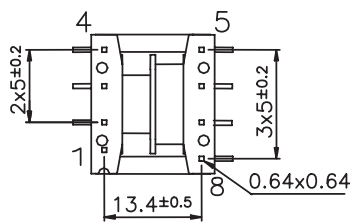
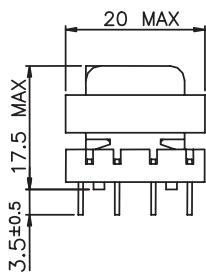
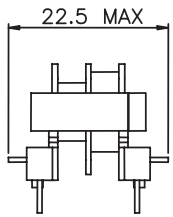

Pin 1 removed for locating

PCB drill @ Ø 1.3mm

Weight ≈ 12 g

74630 - 74631 Size E25

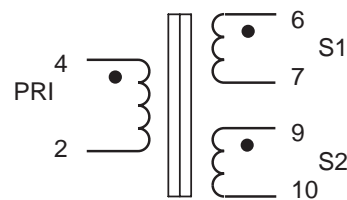
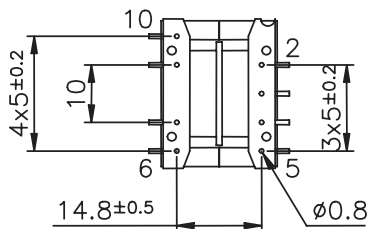
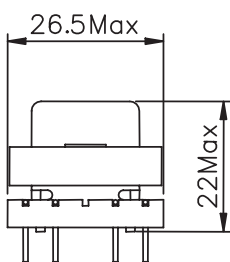
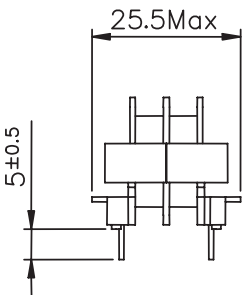

Pins 1 & 8 removed for locating

PCB drill @ Ø 1.3mm

Weight ≈ 20 g

HIGH FREQUENCY FERRITE
PULSE TRANSFORMERS

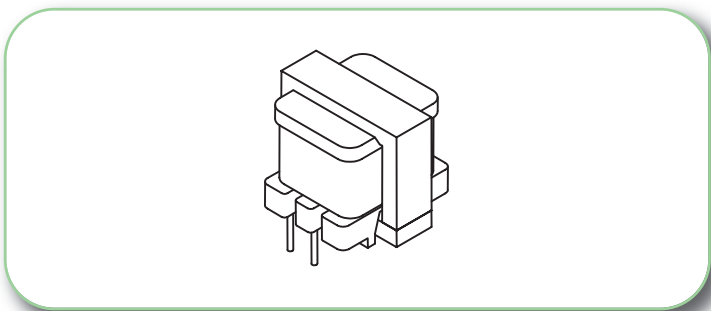

| MYRRA Part N° | Ratio P/S | L pri. +/-30% | Current Arms max | Resistance Ω max | Pulse Vsec. t max | Sine Vsec. max | Insulation Voltage P/S |
|---------------|-----------|---------------|-------------------------|--------------------------------|-------------------|------------------------------------|------------------------|
| 74640 | 1 / 5 | 11 mH | Pri : 0.5 Sec : 0.1 | Pri : 1.0 Sec : 31 | 16 V.ms | 4 Vrms / 50 Hz 50 Vrms / 5 kHz | 1500 |
| 74641 | 1 / 10 | 11 mH | Pri : 0.4 Sec : 0.04 | Pri : 1.8 Sec : 80 Ω | 33 V.ms | 8 Vrms / 50 Hz 100 Vrms / 5 kHz | 1500 |

SAFETY :

- These products are only composed of UL-V0 approved materials.

74640-74641 Size E19-V

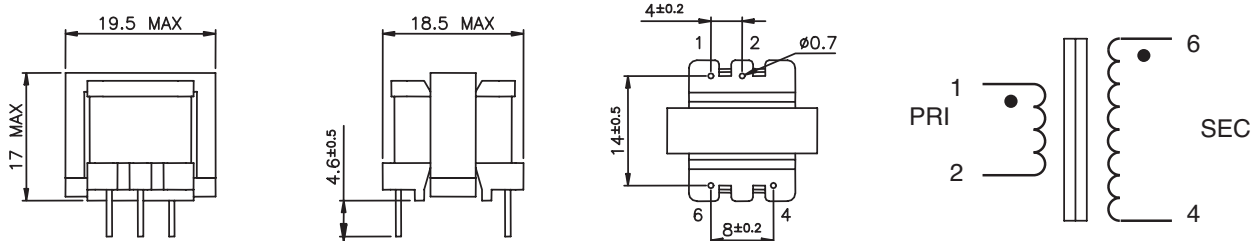

Pins 3 & 5 removed for locating

PCB drill @ \varnothing 1.1mm

Weight \approx 14 g

HIGH FREQUENCY FERRITE
PULSE TRANSFORMERS

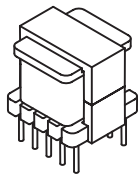

74650

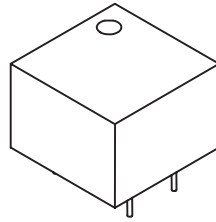

74710

| MYRRA Part N° | Ratio P/S1/S2 | L pri. | Current / winding Arms max | Resistance / winding Ω max | Pulse Ext V.µs max | square V / kHz max | C P/S pF max | Lleak P/S max | Insulation Voltage | |
|---------------|---------------|---------------|----------------------------|----------------------------|--------------------|--------------------|--------------|---------------|--------------------|--------|
| | | | | | | | | | P/S | S1/S2 |
| 74650 | 1 / 1 / 1 | 500 µH +/-30% | 0.6 | 0.28 | 120 V.µs | 20V/ 100kHz | 12 pF | 2 µH | 1.5 kV | 1.5 kV |
| 74710 | 1 / 1 | 2 mH +/-40% | 0.6 | 0.6 | 300 V.µs | 50V/ 100kHz | 6 pF | 44 µH | 4 kV | |

- 74650 is principally designed for Mosfet drive in SMPS (Forward or Bridge converters)
- 74710 is principally designed for SCR Triggering

SAFETY :

These products are only composed of UL-V0 approved materials.

The product 74710 has a construction conform to CEI950, CEI335, CEI61558 for Reinforced insulation (8 mm creepage distance)

74650 Size E13

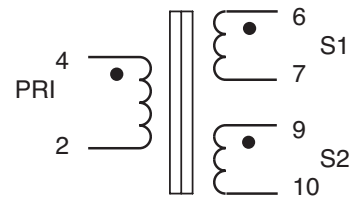
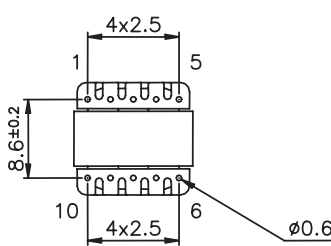
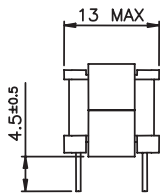
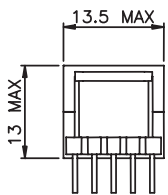

Pin 8 removed for locating

PCB drill @ Ø 1.1mm

Weight ≈ 4 g

74710 Size E16

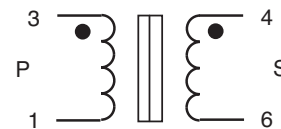
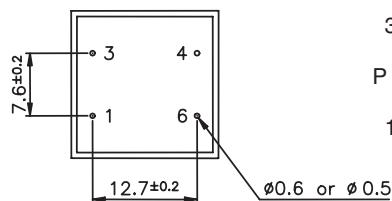
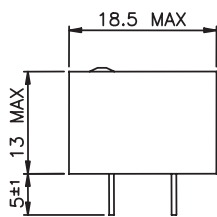
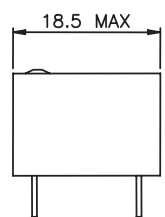

PCB drill @ Ø 1.1mm

Weight ≈ 8 g

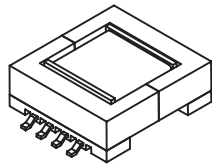

74660 - 74661

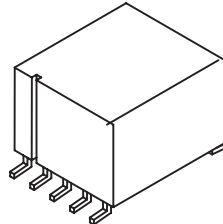

74670

| MYRRA Part N° | Ratio P/S | L pri. | Current / winding max | Resistance / winding Ω max | Pulse E x t max P1 or P2 | square V / kHz max P1 or P2 | C P/S pF max | Lleak P/S max | Insulation Voltage |
|---------------|---------------|--------------------|-----------------------|-----------------------------------|--------------------------|-----------------------------|--------------|---------------|--------------------|
| | | | | | | | | | P/S |
| 74660 | 1+1 / 1.3+1.3 | 240 μ H +/-30% | 0.2 Arms | 0.9 | 50 V. μ s | 15V 100 – 500kHz | 20 pF | 0.35 μ H | 0.5 kV |
| 74661 | 1+1 / 1+1 | 10 μ H +/-10% | 3 Apeak 0.5 Arms | 0.2 | 30 V. μ s | 0.05 V / kHz 100 – 400kHz | 20 pF | 0.2 μ H | 0.5 kV |
| 74670 | 1+1 / 1.3 | 220 μ H +/-30% | 0.4 Arms | 0.25 | 15 V. μ s | 0.03 V / kHz 100 – 500kHz | 12 pF | 0.4 μ H | 4 kV |

- 74660 can be used in association with MAXIM MAX250 or MAX253
- 74661 can be used in association with LINEAR TECHNOLOGY LT1424
- 74660 can be used in association with MAXIM MAX845

SAFETY :

These products are only composed of UL-V0 approved materials.

74660 – 74661 Size EEM12.7

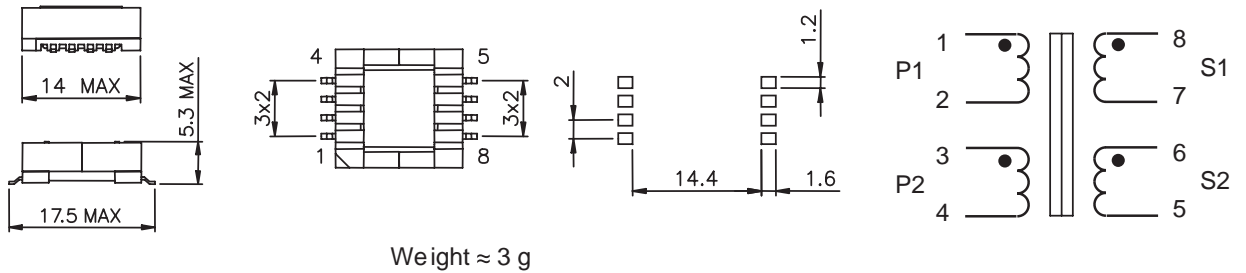

74670 Size T10

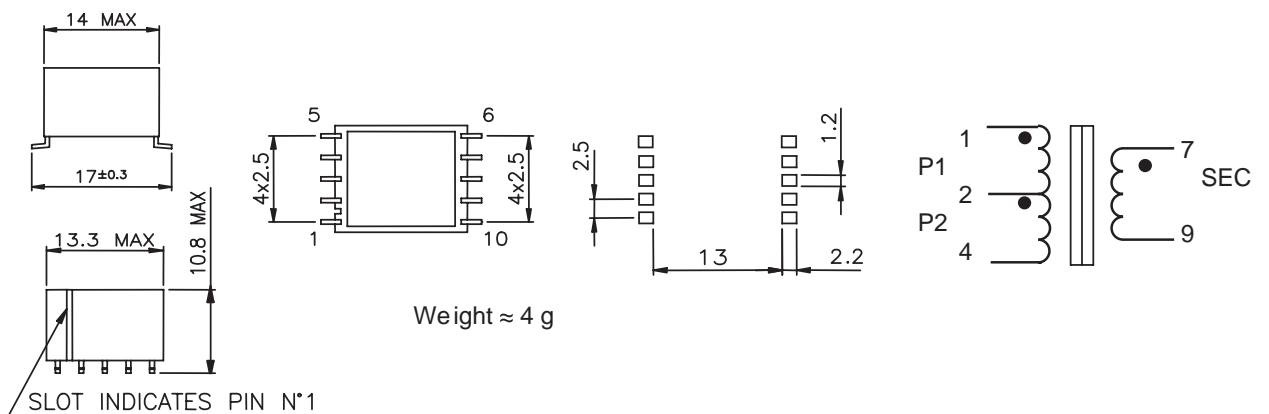

HIGH FREQUENCY FERRITE PULSE TRANSFORMERS

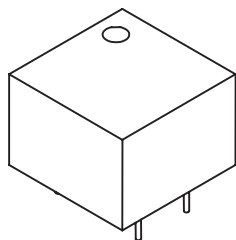

74710 - 74716 - 74717

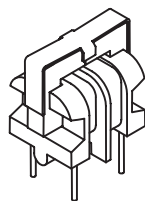

74711

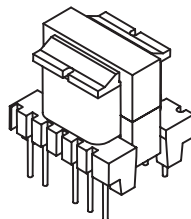

74712

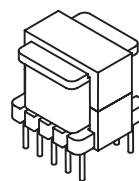

74713

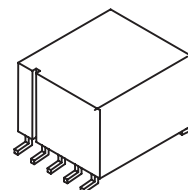

74714 - 74715

- Designed for coupling signals to power line
- Adapted for use with Modem Circuits : **ST7537, ST7538, TDA5051 or IC/SS**

| MYRRA Part N° | Inductance (µH) | Leakage Inductance (µH) | Resistance per winding P/ S (max) | Frequency range | Turns ratio P/ S | Max Sec. current (mA rms) (50 - 60 Hz) | Insulation (Vrms) | Size |
|---------------|--------------------|-------------------------|-----------------------------------|-----------------|------------------|--|-------------------|---------|
| 74714 | 1300 +/-40 % (2-4) | < 0.5 | 0.2 Ω / 0.2 Ω | 10 – 200kHz | 1 / 1 | 4 | 5500 | T10-SMD |
| 74715 | 3.0 +/-25 % (7-9) | < 0.1 | 0.06 Ω / 0.1 Ω | 1 – 20 MHz | 2 / 1+1 | 200 | 4000 | T10-SMD |

74714 - 74715

Reinforced insulation, creepage distance > 8 mm

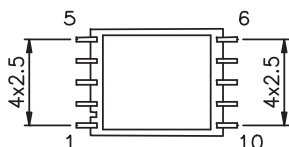
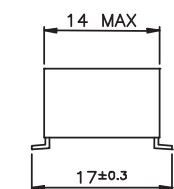

74714

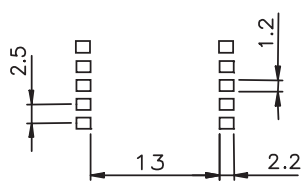
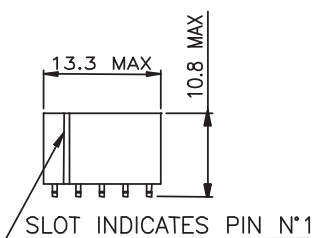
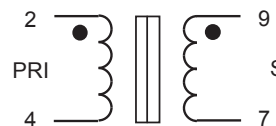

74715

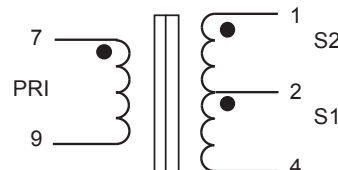

HIGH FREQUENCY FERRITE
POWER LINE COMMUNICATION



| MYRRA Part N° | Inductance (µH) | Leakage Inductance (µH) | Resistance per winding P / S (max) | Frequency range | Turns ratio P / S | Max Sec. current (mA rms) (50 - 60 Hz) | Insulation (Vrms) | Size |
|---------------|----------------------|-------------------------|------------------------------------|-----------------|-------------------|--|-------------------|--------------|
| 74710 | 2000 +/-40 % (1-3) | 44 +/-7% | 0.6 Ω / 0.6 Ω | 10 – 450kHz | 1 / 1 | 10 | 4000 | EF16-H-4P |
| 74711 | 2900 +/-40% (1-2) | 44 +/-7% | 1 Ω / 1 Ω | 10 – 200kHz | 1 / 1 | 4 | 1500 | U9.8-4P |
| 74716 | 45000 +/- 40 % (3-1) | 1500 +/-10 % | 12 Ω / 14 Ω | 10 - 200kHz | 1/1.15 | 4 | 4000 | EF 16 H - 5P |
| 74717 | 400 +/- 40 % (3-1) | 14.4 +/- 10 % | 0.3 Ω / 0.5 Ω | 20 - 450kHz | 1/1.67 | 40 | 4000 | EF 16 H - 5P |

• 74710 - 74711 - 74716 – 74717

Typical application :

Designed for resonance of series coupling capacitor and the transformer leakage inductance.

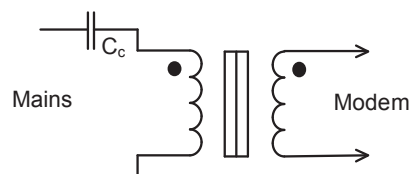

| MYRRA Part N° | Series Resonance Frequency (kHz) | Mains Coupling capacitance (nF) |
|---------------|----------------------------------|---------------------------------|
| 74710 | 132.5 | 33 |
| 74711 | 132.5 | 33 |
| 74716 | 50 | 6.8 |
| 74717 | 40 - 90 | 470 |

74710 Reinforced insulation, creepage distance > 8 mm

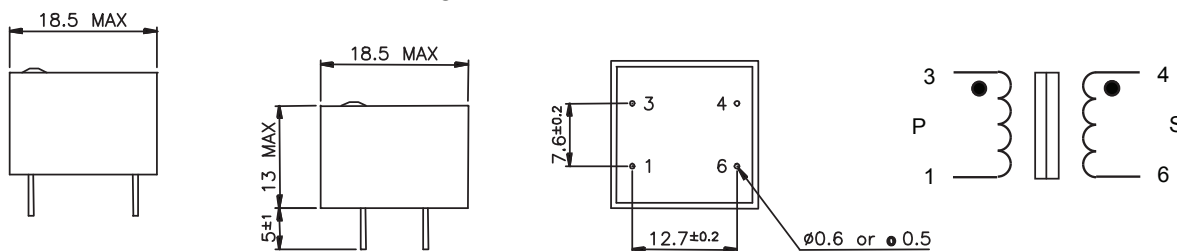

74711 Functional insulation

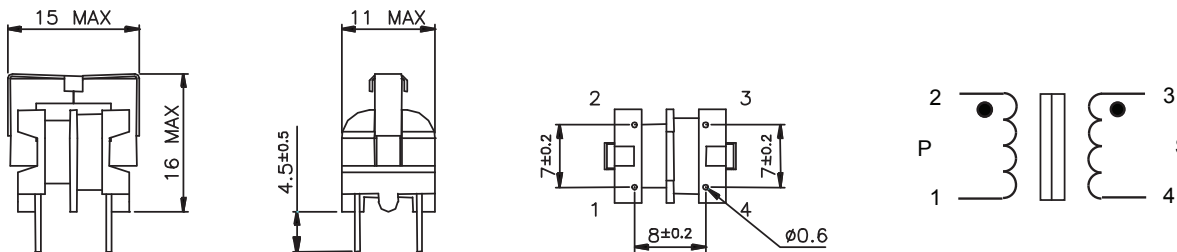

74716 - 74717 Reinforced insulation, creepage distance > 8 mm

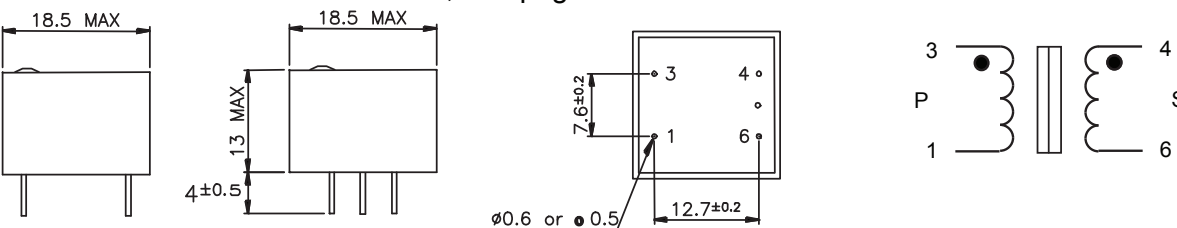

HIGH FREQUENCY FERRITE
POWER LINE COMMUNICATION



| MYRRA Part N° | Inductance (μH) | Leakage Inductance (μH) | Resistance per winding P / S (max) | Frequency range | Turns ratio P / S | Max Sec. current (mA rms) (50 - 60 Hz) | Insulation (Vrms) | Size |
|---------------|-------------------|-------------------------|------------------------------------|-----------------|-------------------|--|-------------------|-----------|
| 74712 | 212 +/-10 % (2-5) | <5 (2-5) | 0.8 Ω / 0.04 Ω | 10kHz – 1MHz | 5+1 / 1 | 500 | 4000 | E16-V-10P |
| 74713 | 144 +/-10 % (2-5) | <5 | 0.5 Ω / 0.5 Ω | 10 – 450kHz | 5+1 / 5+1 | 200 | 1500 | E13-V-10P |

• 74712 - 74713

Typical application :

Designed for resonance of parallel capacitor with the primary magnetizing inductance.

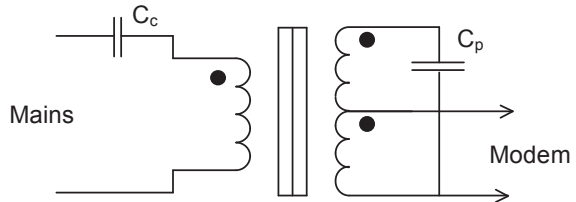

| MYRRA Part N° | Parallels Resonance Frequency (kHz) | Mains Coupling capacitor(nF) | Parallel capacitor (nF) |
|---------------|---------------------------------------|------------------------------|---------------------------|
| 74712 | 132.5 | 33 | 6.8 |
| 74713 | 132.5 | 33 | 10 |

74712

Reinforced insulation, creepage distance > 6 mm

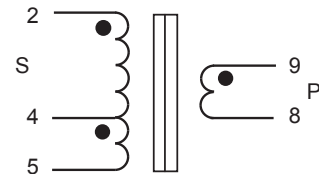
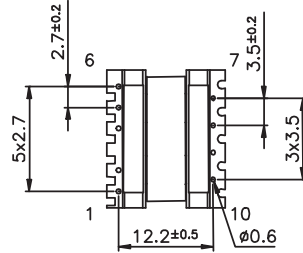
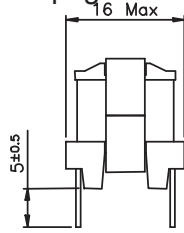
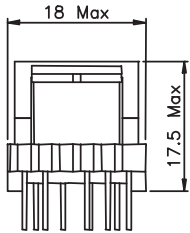

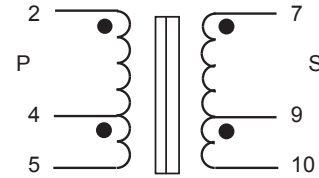
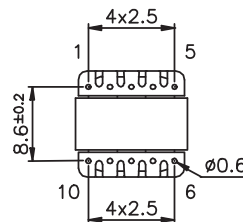
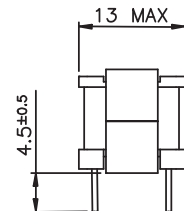
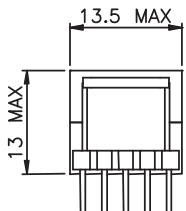

74713

Functional insulation





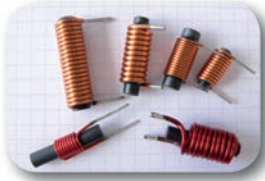

THROUGH HOLES CHOKES

| | Available sizes | Values | Applications |
|--|--|--|--|
| DC SERIES  | | Drum Cores | |
| | (\varnothing x H) mm : 04x06 - 05x07 06 x07 - 07x08 - 07x10 08x09 - 09x12 - 10x13 - 11x12 -11x14 - 11x18 - 13x15 | 1 μ H to 150 mH - 9.3 to 0.03 ADC | DC-DC converters ADSL-computers |
| RC SERIES  | | Rod Chokes | |
| | (\varnothing xL) : 02x06 - 03x10 04x15 - 05x20 - 06x30 | 1 to 56 μ H - 0.56 to 1.57 ADC | Power supply - Power amplifier |
| CMT SERIES  | | Common Mode Toroids | |
| | on request | on request | Power supply EMI suppression Wideband chokes |

SURFACE MOUNT CHOKES

| | Available sizes | Values | Applications |
|--|---|--|---|
| PI SERIES  | | Power inductors | |
| | 32 - 42 - 43 - 53 - 54 - 73 75 - 104 - 105 | 1 to 820 μ H 0.24 to 6.8 A | DC-DC converters DC-AC inverters Switching power supplies |
| SPI SERIES  | | Shielded Power inductors | |
| | 73 - 74 - 124 - 125 - 127 | 1.2 to 1000 μ H 10.6 to 0.18 Arms | DC-DC converters DC-AC inverters Chargers |

POWER SUPPLIES 1W to 60W



MYRRA encapsulated Switched Mode Power Supplies is based on Flyback topology.

They constitute an interesting alternative to the traditional supply in the most common applications of power from 1W to 60W.

ENERGY SAVING due to high efficiency and low standby power.

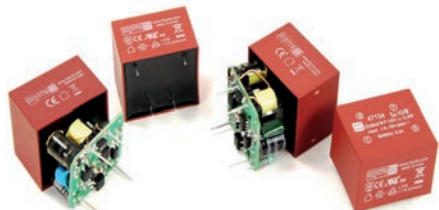

MAIN FEATURES

- Wide input voltage range
- Increased power: 3 x compared to standard EE20-EI30-EI38 transformers
- Better energetic efficiency: 70% typical compared to 40% for the conventional supply
- Very low Standby Power consumption: meets requirements of Energy Star or EC Code of Conduct
- Same footprint as EE20-EI30-EI38-EI48 transformer: (1W~10W)
Upgrade your application without redesign of PCB

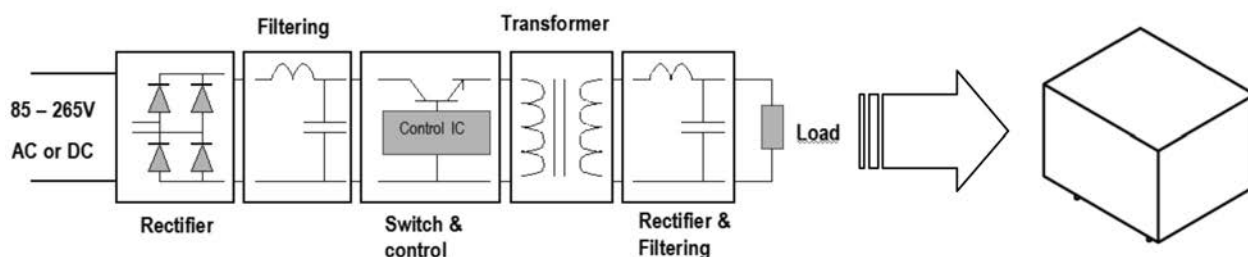

Application for our Power Supplies:

- Alternative to the linear transformers in all AC/DC applications of power up to 60W
- Alternative to DC/DC converters for application in D.C. current (Telecom supplies, electric substations etc.)
- Industrial, domestic and consumer electronics applications
- Standby devices and others DC or AC auxiliary supplies

With the same footprint as an EI30 transformer, they will replace:

- 50 Hz Transformer
- Fuse
- Bridge Rectifier
- Filtering Capacitor

Regulated types will also replace linear regulator and heatsink

SAFETY STANDARDS

Meets all requirements of:

- EN 60950
- EN 60335
- EN 61558-2-16
- EN 61558-1
- UL 60950-1
- CSA 22.2 N°60950-1
- UL 94-V0

EMC STANDARDS

Conducted and radiated emissions conform to

- EN 55014-1
- EN 55032 class B

Immunity conform to

- EN 55014-2
- EN 61000-4-x



1W to 3W

3 Certified Power Ratings
in
1 Power Supply



2.5W to 5W



7.5W



10W



20W to 60W

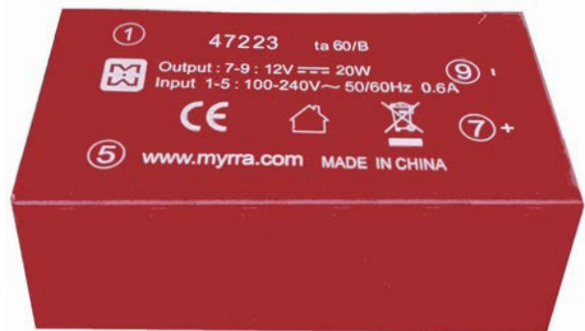



48000 Series

Single Output 1W ~3W

47000 Series

Single Output 2.5W ~ 5W

Single Output 2.4W ~ 5W (relaxed regulation)

Dual Output 3W ~ 5W (common ground)

Dual Output 3W ~ 4W (isolated outputs)

Single Output 7.5W

Single Output 10W

Single Output 20W

Single Output 30W ~ 40W

Single Output 40W ~ 60W

Modified and Custom Solutions

TECHNICAL SERVICES :

- Alternative DC Output Voltages
- Single, Dual or Triple Output Voltages
- Addition of Signal Pins for AC OK, Remote on/off, sense etc.
- Alternative Power Rating
- Revised 'Hold-up' timing to suit System needs
- Customer specific product 'Branding/Labeling'
- Specific Power Supply Manufacturing Functional Test Profile
- Integrating the Power Supply on the System PCB
- Alternative Power Supply Housing
- Revised DC Output Filtering

CUSTOMER SERVICES :

- Existing Designs for Modified Standards
- Flexible Manufacturing Batch Sizes
- European Stock-holding locations
- European Engineering and Logistics Support
- Country Specific Distribution Partners
- Manufacturing dynamics for Volume Fluctuations
- Myrra Quality Controlled Design and Manufacturing
- Fast Sample Service

Dedicated Power Supplies Catalogue available
Encapsulated Solutions 1W to 60W

hard copy or online at Myrra.com



POWER PRODUCTS TECHNOLOGIES

One of Myrra core competence is to provide customers with a high level of production technology combining know-how and experience over 40 years.

High-frequency transformers and chokes up to 100KW
Lamination 50Hz transformers and chokes up to 20KVA

- **Core** : Laminated steel for 50Hz
Amorphous Core
Nanocrystalin Cores
Powder Core / Sendust / Megaflux / High Flux
Ferrites Core
- **Winding mono or multi-spindle**
Copper or Aluminum
 - Round enameled wire / Litz Wire / TIW
 - Flat wire (rectangular)
 - Foil : up to 400 mm width up to 10 layers simultaneously
- **Automatic or Manual soldering machine** (standard and ultrasonic)
- **Automatic welding machine** up to EI180
- **Varnish** Automatic under vacuum, until 1m3 volume
- **Potting** under vacuum / UL94V0 / EN45545
- **Automatic test system** No Load Test / Full Load Test / Computer controlled
- **Traceability**
 - Parts : Serial Numbers / Barcode
 - Materials : Manufacturer Program / C.O.C.
- **Insulation systems** : B, F, H classes
UL , IEC , CSA compliant

POWER PRODUCTS CONTROL WORKING STATION

A high level of control at all stages of production
100% of parts are tested

Labview software implementation on control station

- With automatic multiplexer MUX

All our test equipments are under calibration :

- Precision multimeters
- Micro-ohmmeters
- Oscilloscopes and Functions Generators
- Impulse Winding Tester 5kV
- Surge Test 12 kV
- HiPot Tester 12 kV
- RLC Impedance Meters, & 75 A DC Bias
- Power HiTester
- Pulse Generator / Saturation Tester

All products are controlled at 100 % during process (1 to 3 times)
and once again at 100% before packaging (final control).



POWER PRODUCTS APPLICATIONS

Myrra is able to demonstrate a great adaptability to the needs and the requirements of the customers with a very high level of competence internationally recognized.

SOLAR

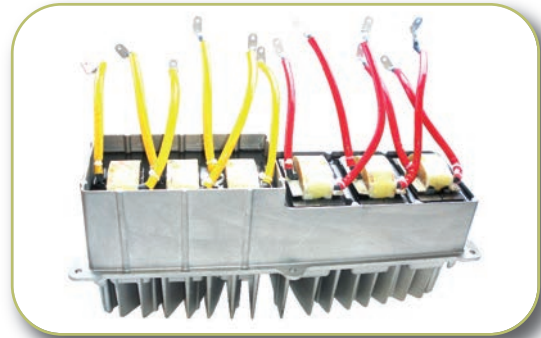
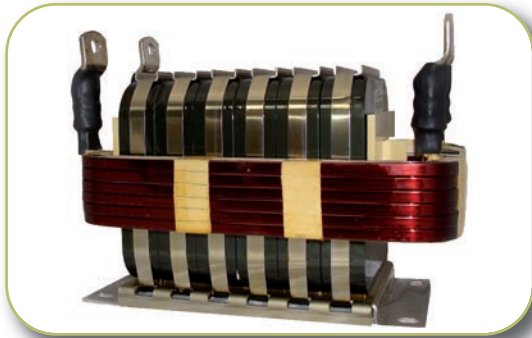

MACHINERY

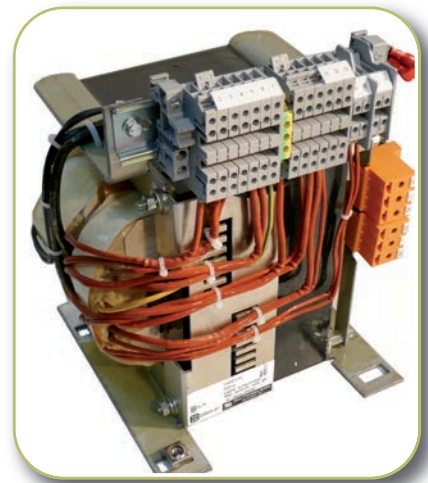
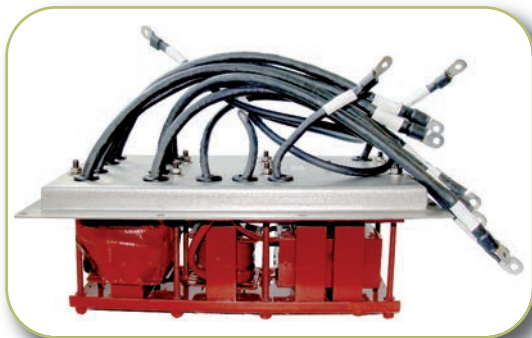

MOTORDRIVE

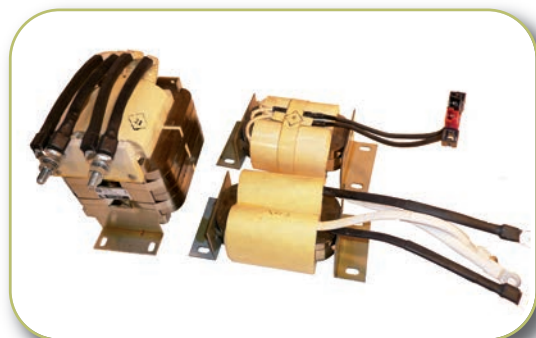
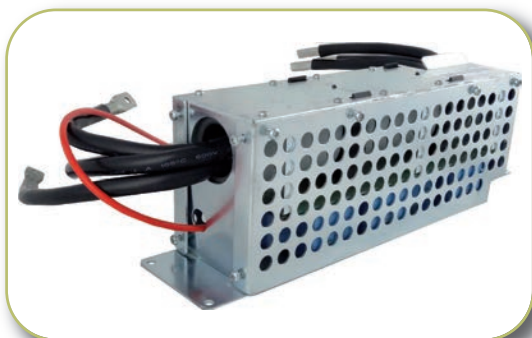



Save valuable time for your specific request for non-standard products



Reminder of the data needed to easily validate your request

Technical:

For all Request:

| | |
|------------------------------|----------------------|
| Ambient | <input type="text"/> |
| Max dimensions | <input type="text"/> |
| Required standards approvals | <input type="text"/> |

Encapsulated Transformers

| | |
|-----------------------|----------------------|
| Transfo // Autotr. | <input type="text"/> |
| Power (VA) | <input type="text"/> |
| Input voltage (V) | <input type="text"/> |
| Output voltage(s) (V) | <input type="text"/> |
| Output current(s) (A) | <input type="text"/> |
| Frequency (Hz) | <input type="text"/> |

Chokes (power and 50 Hz)

| | |
|---------------------------|----------------------|
| Type (AC // DC // PFC...) | <input type="text"/> |
| Inductance value (mH) | <input type="text"/> |
| Current (Arms) | <input type="text"/> |
| Ripple freq. (kHz) | <input type="text"/> |
| Ripple current (Apkpk) | <input type="text"/> |
| Derating curve (L Vs I) | <input type="text"/> |

Common Mode Chokes

| | |
|-----------------------|----------------------|
| Inductance value (mH) | <input type="text"/> |
| Current (A) | <input type="text"/> |
| Phases number | <input type="text"/> |

HF transformers

| | |
|---|----------------------|
| Power (W) | <input type="text"/> |
| Topology (Flyback // forward ...) | <input type="text"/> |
| Input voltage range (V) Output voltage(s) (V) | <input type="text"/> |
| Output current(s) (A) Frequency (kHz) | <input type="text"/> |
| Controller (*) | <input type="text"/> |
| Level of insulation | <input type="text"/> |
| Pollution degree | <input type="text"/> |

Current transformers

| | |
|-----------------------------|----------------------|
| Primary current (Arms) | <input type="text"/> |
| Ratio | <input type="text"/> |
| Load (Ω) | <input type="text"/> |
| Frequency (Hz) | <input type="text"/> |
| Accuracy | <input type="text"/> |
| Through hole // Primary pin | <input type="text"/> |
| Insulation level | <input type="text"/> |

Commercial:

| | |
|-----------------------|----------------------|
| Quantity / year | <input type="text"/> |
| Application | <input type="text"/> |
| Project | <input type="text"/> |
| Production start date | <input type="text"/> |
| Contact details | <input type="text"/> |

*Go to Design on Request online:
myrra.com*



www.myrra.com

**

MYRRA SAS
2 Bd de la Haye
Parc Gustave Eiffel
77600 Bussy St Georges
France

MYRRA Deutschland GmbH
Marie-Curie-Straße 4/1
71083 Herrenberg
Germany