



Simply Reliable

2020 Good Will Instrument Co., Ltd.

SHORTFORM

OSCILLOSCOPES

SPECTRUM ANALYZERS

SIGNAL SOURCES

POWER SUPPLIES

DIGITAL MULTIMETERS
LCR METERS
SAFETY TESTERS
OTHER METERS

www.gwinstek.com

OSCILLOSCOPES

- Digital Storage Oscilloscope
- Mixed-signal Oscilloscope
- Mixed-domain Oscilloscope

- Handheld Digital Storage Oscilloscope
- Oscilloscope Education and Training Kit

P 2 ~ 6

SPECTRUM ANALYZERS

- 3.25 GHz Spectrum Analyzer
- 3 GHz Spectrum Analyzer
- 1.8 GHz Spectrum Analyzer

- ASK/FSK/TPMS Tester
- IoT LoRa Tester
- RF Training System

P 7 ~ 10

SIGNAL SOURCES

- Arbitrary Function Generator
- Multi-Channel Function Generator
- True Dual Channel Arbitrary Function Generator

- DDS Function Generator
- Analog Function Generator
- RF Signal Generator

P 11 ~ 12

POWER SUPPLIES

- Programmable Linear D.C. Power Supply
- Linear D.C. Power Supply
- Programmable Switching D.C. Power Supply
- Switching D.C. Power Supply
- Programmable A.C./D.C. Power Source

- Programmable Linear A.C. Power Source
- Linear A.C. Power Source
- Programmable D.C. Electronic Load
- D.C. Electronic Load
- Current Shunt Meter

P 13 ~ 18

DIGITAL MULTIMETERS/LCR METERS/SAFETY TESTERS/OTHER METERS

- Digit Dual Measurement Multimeter
- Digital Multimeter
- Mini Clamp Meter
- LCR Meter
- Handheld LCR Meter
- Logic Probe & Pulsar
- Electrical Safety Analyzer
- Electrical Safety Tester
- AC Ground Bond Tester

- Digital IC Tester
- Handy Linear IC Tester
- Automatic Distortion Meter
- D.C. Milli-ohm Meter
- Digital Power Meter
- Battery Meter
- Intelligent Counter
- Digital Frequency Counter
- A.C. Millivolt Meter

P 19 ~ 22



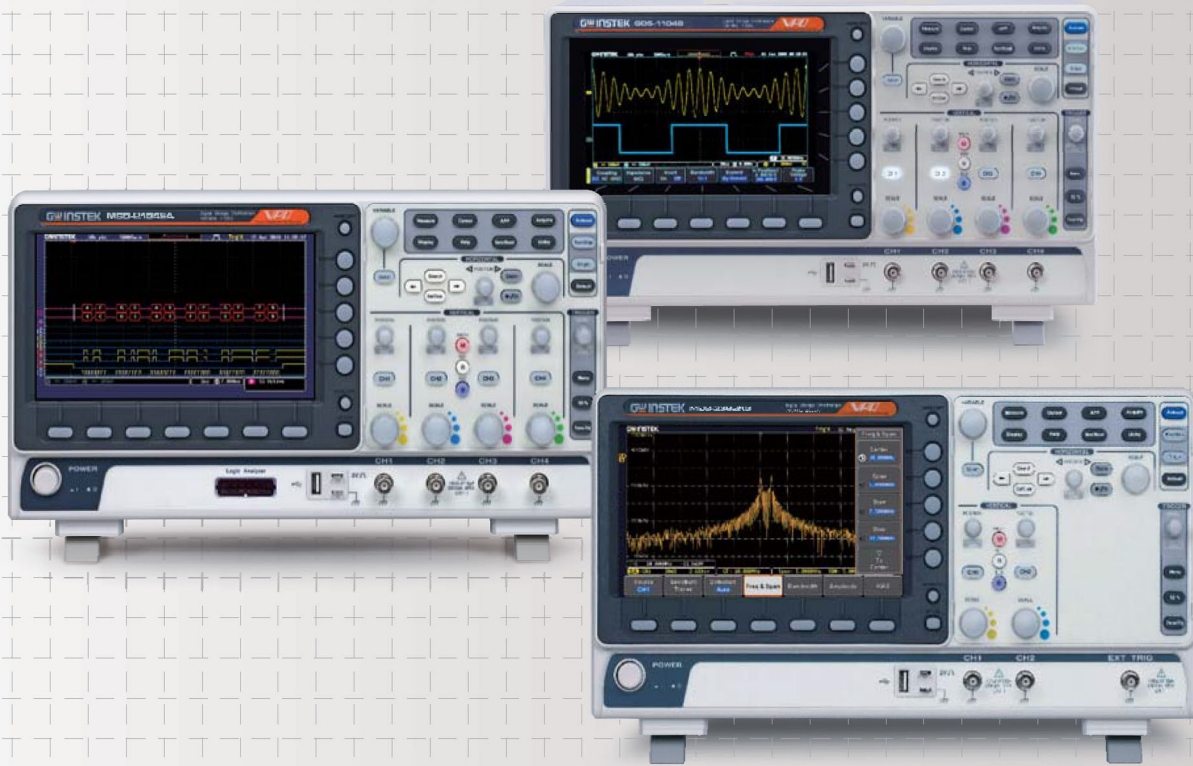

GDS-1000B Series 100/70/50MHz Digital Storage Oscilloscope
MSO-2000E Series 200/100/70MHz Mixed-signal Oscilloscope
MDO-2000A Series 300/200/100MHz Mixed-domain Oscilloscope

OSCILLOSCOPES

The frequency bandwidth ranges from 50MHz to the high-class 500MHz. In addition, up to 5GSa/s realtime sampling rate and 20M points memory depth can pick up and hold the complete signal in order to preserve the accuracy. PC interfaces such as USB, LAN, GPIB, RS-232C, and Printer Port are integrated to the panel to satisfy data transmit/save needs.

The MSO-2000E series is a mixed-signal oscilloscope, which offers dual analog channels+16 digital channels or 4 analog channels+16 digital channels. MSO-2000E has a built-in 16-channel logic analyzer and MSO-2000EA has a built-in 16-channel logic analyzer and a dual channel 25MHz arbitrary function generator. The MDO-2000A series is multi-functional mixed domain oscilloscope. While entering the spectrum mode, MDO-2000A series will display a full screen of frequency domain. Users can input Center frequency, Span, Start frequency, and Stop frequency based upon test requirements so as to rapidly and intuitively observe required frequency range that allows users to experience the user interface of a real spectrum analyzer. MSO-2000EA, MDO-2000AG and MDO-2000E also provide frequency response analysis function, it allows users to obtain DUT's FRA characteristic curve plot (Bode plot).

PRODUCTS

- Digital Storage Oscilloscope
- Mixed-signal Oscilloscope
- Mixed-domain Oscilloscope
- Handheld Digital Storage Oscilloscope
- Oscilloscope Education and Training Kit

500/350/250/150MHz Digital Storage Oscilloscope



GDS-3504/3354/3254/3154

- * 5GSa/s Real-time Sampling Rate and 100GSa/s Equivalent Time Sampling Rate
- * 25k Points Memory for Each Input Channel
- * VPO (Visual Persistence Oscilloscope) Technology to Display Less-Frequently-Occurred Signals
- * 8" 800 x 600 High Resolution TFT LCD Display
- * Unique Split Screen System with Independent Setting and Display for Each Input Channel
- * Three Input Impedance Selections: 50Ω/75Ω/1MΩ
- * Optional Power Analysis Software for Power Source Measurement and Analysis
- * Optional Serial Bus Analysis Software for Trigger & Decode of I²C, SPI and UART Interfaces

500/350/250/150MHz Digital Storage Oscilloscope

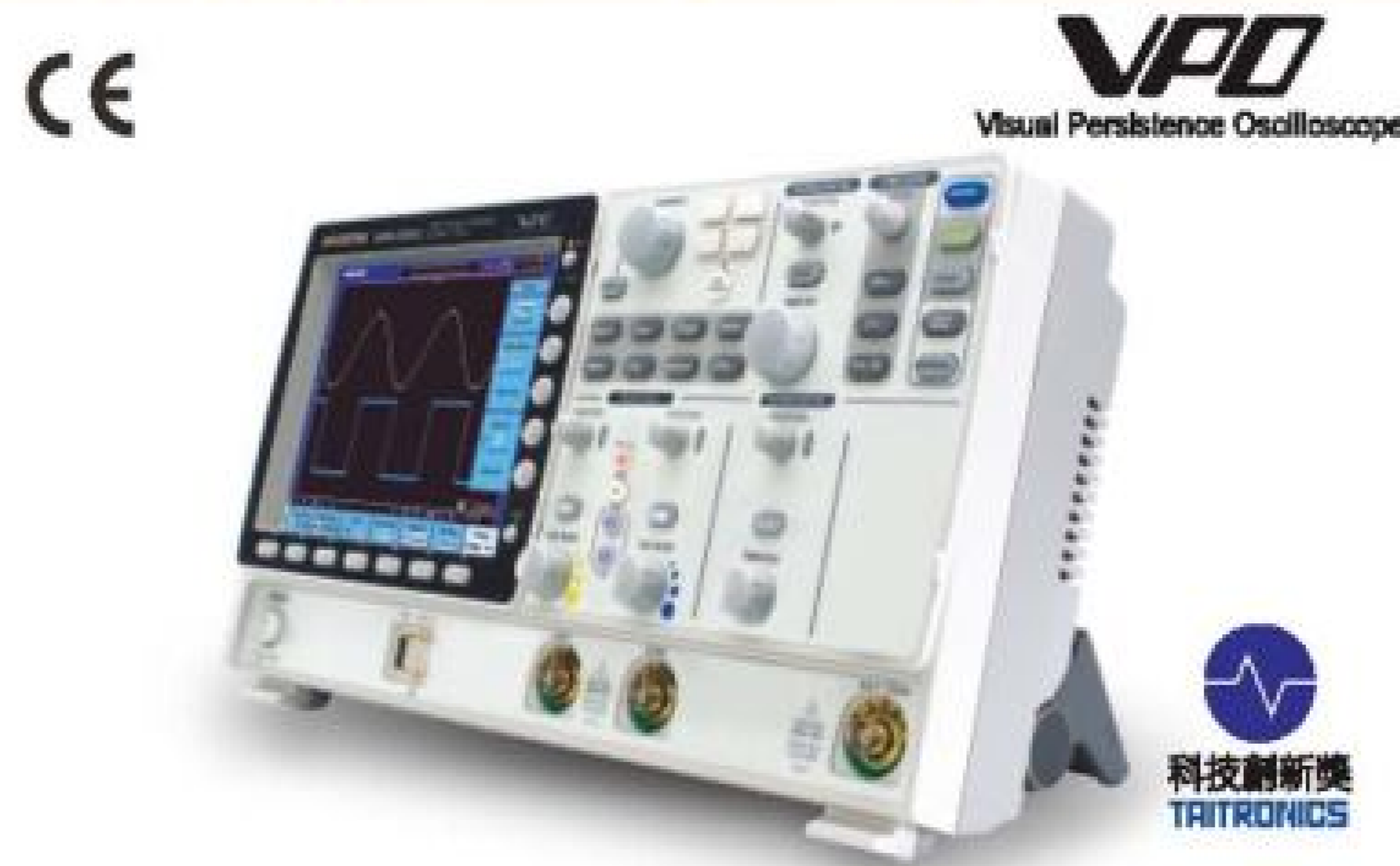

GDS-3502/3352/3252/3152

- * 5GSa/s Real-time Sampling Rate and 100GSa/s Equivalent Time Sampling Rate
- * 25k Points Memory for Each Input Channel
- * VPO (Visual Persistence Oscilloscope) Technology to Display Less-Frequently-Occurred Signals
- * 8" 800 x 600 High Resolution TFT LCD Display
- * Unique Split Screen System with Independent Setting and Display for Each Input Channel
- * Three Input Impedance Selections: 50Ω/75Ω/1MΩ
- * Optional Power Analysis Software for Power Source Measurement and Analysis
- * Optional Serial Bus Analysis Software for Trigger & Decode of I²C, SPI and UART Interfaces

300/200/100/70MHz Digital Storage Oscilloscope



GDS-2304A/2204A/2104A/2074A

- * 2GSa/s Real-time Sampling Rate and 100GSa/s Equivalent Time Sampling Rate
- * 2MegaPoints Record Length
- * Fastest 80,000 wfm/s of Waveform Update Rate
- * Segmented Memory Acquisition and Waveform Search Functions
- * Standard Model Provides I²C, UART, SPI, CAN/LIN Serial Bus Trigger and Decoding Functionalities
- * Optional 8 or 16 digital channel with Logic analyzer(MSO)
- * Optional 5MHz and 25MHz Function Generator
- * Upgradable, Advanced Logic, Datalog, DVM and H-expansion Functionalities

300/200/100/70MHz Digital Storage Oscilloscope



GDS-2302A/2202A/2102A/2072A

- * 2GSa/s Real-time Sampling Rate and 100GSa/s Equivalent Time Sampling Rate
- * 2MegaPoints Record Length
- * Fastest 80,000 wfm/s of Waveform Update Rate
- * Segmented Memory Acquisition and Waveform Search Functions
- * Standard Model Provides I²C, UART, CAN/LIN, Serial Bus Trigger and Decoding Functionalities
- * Optional 8 or 16 digital channel with Logic analyzer(MSO)
- * Optional 5MHz and 25MHz Function Generator
- * Upgradable, Advanced Logic, Datalog, DVM and H-expansion Functionalities

200/100/70MHz Mixed-signal Oscilloscope



MSO-2204E/2104E/2074E

- * Maximum Real Time Sample Rate : 1 GSa/s
- * MSO-2000E Equips with a 16 Channel Logic Analyzer
- * MSO-2000EA Equips with a 16 Channel Logic Analyzer and a Dual Channel 25MHz Arbitrary Waveform Generator
- * Free Frequency Response Analyzer Software for MSO-2000EA
- * Maximum 10M Memory Depth and VPO Waveform Display Technology
- * Waveform Update Rate up to 120,000 wfm/s
- * 8" WVGA TFT LCD
- * Maximum 1M FFT Provides Higher Frequency Domain Resolution Measurements
- * High Pass, Low Pass and Band Pass Filter Functions
- * I²C/SPI/UART/CAN/LIN Serial Bus Trigger and Decoding Functions
- * Mask Test Function

200/100/70MHz Mixed-signal Oscilloscope



MSO-2202E/2102E/2072E

- * Real Time Sample Rate : 1GSa/s Per Channel
- * MSO-2000E Equips with a 16 Channel Logic Analyzer
- * MSO-2000EA Equips with a 16 Channel Logic Analyzer and a Dual Channel 25MHz Arbitrary Waveform Generator
- * Free Frequency Response Analyzer Software for MSO-2000EA
- * Maximum 10M Memory Depth and VPO Waveform Display Technology
- * Waveform Update Rate up to 120,000 wfm/s
- * 8" WVGA TFT LCD
- * Maximum 1M FFT Provides Higher Frequency Domain Resolution Measurements
- * High Pass, Low Pass and Band Pass Filter Functions
- * I²C/SPI/UART/CAN/LIN Serial Bus Trigger and Decoding Functions
- * Mask Test Function

300/200/100MHz Mixed-Domain Oscilloscope



MDO-2302A(G)/2202A(G)/2102A(G)

- * 300/200/100MHz Bandwidth Selections: 2 Channels
- * Maximum Real Time Sampling Rate: 2 GSa/s
- * MDO-2000A Equips with a Spectrum Analyzer; MDO-2000AG Equips with a Spectrum Analyzer, a Dual Channel 25MHz AWG
- * Per Channel 20M Memory Depth and VPO Waveform Display Technology
- * Waveform Update Rate up to 120,000 wfm/s & 8" WVGA TFT LCD
- * MDO-2000AG Provides Frequency Response Analysis Function
- * Maximum 1M FFT Provides Higher Frequency Domain Resolution Measurements
- * High Pass, Low Pass and Band Pass Filter Functions
- * 29,000 Segmented Memory Sections and Waveform Search Function
- * I²C/UART/CAN/LIN Serial Bus Trigger and Decoding Functions
- * Data Log Function is able to Track Signal Changes up to 1000 Hours
- * Mask Test Function & Network Storage Function

200/100/70MHz Mixed-domain Oscilloscope



MDO-2204E/2104E/2074E

- * Maximum Real Time Sample Rate: 1 GSa/s (4 Channel Models)
- * MDO-2000EG Equips with a Spectrum Analyzer and a Dual Channel 25MHz AWG
- * MDO-2000EX Equips with a Spectrum Analyzer; a Dual Channel 25MHz AWG; DMM and Power Supply
- * Per Channel 10M Memory Depth and VPO Waveform Display Technology
- * Waveform Update Rate up to 120,000 wfm/s & 8" WVGA TFT LCD
- * Free Frequency Response Analyzer Software
- * Maximum 1M FFT Provides Higher Frequency Domain Resolution Measurements
- * High Pass, Low Pass and Band Pass Filter Functions
- * 29,000 Segmented Memory Sections and Waveform Search Functions
- * I²C/SPI/UART/CAN/LIN Serial Bus Trigger and Decoding Functions
- * Data Log Function is Able to Track Signal Changes up to 1000 Hours
- * Mask Test Function & Network Storage Function

200/100/70MHz Mixed-domain Oscilloscope



MDO-2202E/2102E/2072E

- * Maximum Real Time Sample Rate: 1 GSa/s (2 Channel Models)
- * MDO-2000EG Equips with a Spectrum Analyzer and a Dual Channel 25MHz AWG
- * MDO-2000EX Equips with a Spectrum Analyzer; a Dual Channel 25MHz AWG; DMM and Power Supply
- * Per Channel 10M Memory Depth and VPO Waveform Display Technology
- * Waveform Update Rate up to 120,000 wfm/s & 8" WVGA TFT LCD
- * Free Frequency Response Analyzer Software
- * Maximum 1M FFT Provides Higher Frequency Domain Resolution Measurements
- * High Pass, Low Pass and Band Pass Filter Functions
- * 29,000 Segmented Memory Sections and Waveform Search Functions
- * I²C/SPI/UART/CAN/LIN Serial Bus Trigger and Decoding Functions
- * Data Log Function is Able to Track Signal Changes up to 1000 Hours
- * Mask Test Function & Network Storage Function

200/100/70MHz Digital Storage Oscilloscope



GDS-2204E/2104E/2074E

- * Sampling Rate : Max. 1GSa/s(4ch Model)
- * 10M/ch Memory Depth and VPO Waveform Display Technology
- * Waveform Update Rate of 120,000 wfm/s
- * 8" 800 x 480 TFT LCD Display
- * Max. 1M pts of FFT to Get Higher Resolution in Frequency Domain
- * Digital Filter Function
- * Segmented Memory and Waveform Search Functions
- * I²C/SPI/UART/CAN/LIN Serial Bus Trigger and Decoding Function
- * Data Log Function for Waveform Observation in Long Periods of Time

200/100/70MHz Digital Storage Oscilloscope



GDS-2202E/2102E/2072E

- * 200/100/70MHz Bandwidth
- * Sampling Rate : Per Channel 1GSa/s(2ch Model)
- * 10M/ch Memory Depth and VPO Waveform Display Technology
- * Waveform Update Rate of 120,000 wfm/s
- * 8" 800 x 480 TFT LCD Display
- * Max. 1M pts of FFT to Get Higher Resolution in Frequency Domain
- * Digital Filter Function
- * Segmented Memory and Waveform Search Functions
- * I²C/UART/CAN/LIN Serial Bus Trigger and Decoding Function
- * Data Log Function for Waveform Observation in Long Periods of Time

100/70/50 MHz Digital Storage Oscilloscope



GDS-1104B/1074B/1054B

- * 100MHz/70MHz/50MHz Bandwidth Selections, 4 Input Channels
- * 1GSa/s Maximum Sampling Rate
- * 10M Maximum Memory Depth For Each Channel
- * 7" 800 x 480 WVGA LCD Display
- * 256 Color Gradient Display Function to Strengthen Waveform Performance
- * 1Mpts FFT Frequency Domain Signal Display
- * I²C/SPI/UART/CAN/LIN Serial Bus Trigger and Decoding Functions
- * Zero Key Function For Horizontal Time, Vertical Voltage and Triggering
- * Compact and Innovative Exterior Design

100/70 MHz Digital Storage Oscilloscope



GDS-1202B/1102B/1072B

- * 200MHz/100MHz/70MHz MHz Bandwidth Selections, 2 Input Channels
- * 1GSa/s Maximum Sampling Rate
- * 10M Maximum Memory Depth For Each Channel
- * 7" 800 x 480 WVGA LCD Display
- * 256 Color Gradient Display Function to Strengthen Waveform Performance
- * 1Mpts FFT Frequency Domain Signal Display
- * I²C/UART/CAN/LIN Serial Bus Trigger and Decoding Functions
- * Zero Key Function For Horizontal Time, Vertical Voltage and Triggering
- * Compact and Innovative Exterior Design

100/70/50MHz Digital Storage Oscilloscope



GDS-1102-U/1072-U/GDS-1052-U

- * 100/70/50 MHz Bandwidth, 2 Input Channels
- * 250MSa/s Real-time & 25GSa/s Equivalent Time Sampling Rate
- * 4k Memory Depth per Channel
- * Save/Recall of 15 Front Panel Settings & Waveforms
- * 5.7" Color TFT LCD Display
- * 19 Auto Measurements
- * Math Function: Add, Subtract, FFT
- * USB Host & Device Ports
- * Go/NoGo Function
- * Data Logger
- * Limited Lifetime Warranty

150/100/70MHz Digital Storage Oscilloscope



GDS-1152A-U/1102A-U/1072A-U

- * 150/100/70 MHz Bandwidth, 2 Input Channels
- * 1GSa/s Real-time and 25GSa/s Equivalent Time Sampling Rate
- * 2Mega Points Memory Depth
- * 2mV~10V Vertical Scale & 1ns~50s Horizontal Range
- * Up to 27 Auto Measurements
- * Versatile Math Functions: +, -, x, FFT, FFTrms, Zoom FFT
- * 5.7" Color TFT LCD Display
- * USB Host and Device Interfaces
- * Go/NoGo Function
- * Data Logger
- * Limited Lifetime Warranty

200/100/70 MHz Digital Storage Oscilloscope



Patent No. :
13/671702
ZL201420272063.8
ZL201430150303.2



GDS-300 Series

- * 200/100/70MHz Bandwidth Selections, 2 Input Channels
- * 1GSa/s Maximum Sample Rate
- * Maximum 5M Memory Depth Per Channel
- * 7" 800 x 480 Full Touch Panel Capacitive LCD Multi-Point Control, Landscape and Portrait Display
- * Built-In 50,000 Counts DMM
- * 30,000 Consecutive Waveform Records Logging Function, Replay Measurement Results Any Time
- * Temperature Measurement and Logging Function
- * Built-In Engineering Calculator, SMD Resistance Coding, Color Coding Info, and Attenuator Calculation Application Software
- * Optional Differential Probe to Achieve Isolation Effect

200/100/70 MHz Digital Storage Oscilloscope



Patent No. :
13/671702
ZL201420272063.8
ZL201430150303.2



GDS-200 Series

- * 200/100/70MHz Bandwidth Selections, 2 Input Channels
- * 1GSa/s Maximum Sample Rate
- * Maximum 1M Memory Depth Per Channel
- * 7" 800 x 480 Full Touch Panel Capacitive LCD Multi-Point Control, Landscape and Portrait Display
- * Built-In 5,000 Counts DMM
- * 30,000 Consecutive Waveform Records Logging Function, Replay Measurement Results Any Time
- * Data Logging Function
- * Built-In Engineering Calculator, SMD Resistance Coding, Color Coding Info, and Attenuator Calculation Application Software
- * Optional Differential Probe to Achieve Isolation Effect

40MHz Dual-channel Differential Probe





GDP-040D (for GDS-300/200 Series)





GDP-040D	
Channel	2
Bandwidth (-3dB)	DC ~ 40MHz (x200)
Attenuation	200 X
Voltage Input Range	600Vpp Max.
Output	≤ ±3V
Maximun Input Voltage to Earth Typical CMRR	600Vpp for x200 80dB@60Hz ; 60dB@100Hz ; 50dB@1MHz
Input Impedance	Differential : 2MΩ/1.2pf, Ground 1MΩ/2.4pF
Output Impedance	50Ω
Rise Time	8.75ns for x200
Power Supply	5V DC from GDS-300/200 Series
Accuracy	±2%
Dimension	81.7(H) x 123.0(W) x 28.0(D) mm





High-voltage Differential Probe	High-voltage Differential Probe	High-voltage Differential Probe
		
GDP-025	GDP-050	GDP-100
GDP-025	GDP-050	GDP-100
Probe Bandwidth DC~25MHz DC~15MHz	Probe Bandwidth DC~50MHz	Probe Bandwidth DC~100MHz
Attenuation x20, x50, x200	Attenuation x100, x200, x500, x1000	Attenuation x100, x200, x500, x1000
Accuracy ±2%	Accuracy ±2%	Accuracy ±2%
Voltage Input Range (DC+AC peak to peak) ≤140Vp-p for x 20 ≤350Vp-p for x 50 ≤1400Vp-p for x 200	Voltage Input Range (DC+AC peak to peak) ≤ 700Vp-p for x 100 ≤ 1400Vp-p for x 200 ≤ 3500Vp-p for x 500 ≤ 7000Vp-p for x 1000	Voltage Input Range (DC+AC peak to peak) ≤ 700Vp-p for x 100 ≤ 1400Vp-p for x 200 ≤ 3500Vp-p for x 500 ≤ 7000Vp-p for x 1000

Current Probe	Power Supply	Power Supply
		
GCP-020	GCP-206P (for GCP-530/1030)	GCP-425P (for GCP-530/1030)
GCP-020	GCP-206P	GCP-425P
Probe Bandwidth 40Hz~40kHz	Compatible Current Probe GCP-530 & GCP-1030	Compatible Current Probe GCP-530 & GCP-1030
Rise Time —	Number of Power Supply Connectors 2	Number of Power Supply Connectors 4
Maximum Continuous Input Range 0.1~24A(100mV/A) 0.5~240A(10mV/A)	Output Voltage ±12V± 0.5V	Output Voltage ±12V± 0.5V
Maximum Peak Current Value 60A(100mV/A) 600A(10mV/A)	Rated Output Current ±600mA	Rated Output Current ±2.5A
Output Voltage Rate 10mV/A;100mV/A	Rated Supply Voltage (50/60Hz) 110V/120V, 220V/240VAC±10%	Rated Supply Voltage (50/60Hz) 100V~240V AC±10%
Noise —	Maximum Rated Power 20VA	Maximum Rated Power 170VA
Rate Supply Voltage —	Dimensions & Weight 73(W) x 110(H) x 186(D)mm ; Approx.1.1kg	Dimensions & Weight 80(W) x 119(H) x 200(D) mm ; Approx.1.1kg
Maximum Rated Power —	Accessories Power cord, fuse	Accessories Power cord, fuse
Maximum Rated Voltage 600V, CAT III		

Current Probe	Current Probe	Current Probe
		
GCP-530	GCP-1030	GCP-100
GCP-530	GCP-1030	GCP-100
Probe Bandwidth DC~50MHz	Probe Bandwidth DC~100MHz	Probe Bandwidth DC~100kHz
Rise Time 7ns or less	Rise Time 3.5ns or less	Rise Time —
Maximum Continuous Input Range 30Arms	Maximum Continuous Input Range 30Arms	Maximum Continuous Input Range 0.05~10A(100mV/A) 1~100A(10mV/A)
Maximum Peak Current Value 50A peak	Maximum Peak Current Value 50A peak	Maximum Peak Current Value 100A
Output Voltage Rate 0.1V/A	Output Voltage Rate 0.1V/A	Output Voltage Rate 100mV/A;10mV/A
Noise 2.5mArms or less	Noise 2.5mArms or less	Noise —
Rate Supply Voltage ±12V± 0.5V	Rate Supply Voltage ±12V± 0.5V	Rate Supply Voltage —
Maximum Rated Power 5.6VA	Maximum Rated Power 5.3VA	Maximum Rated Power —
Maximum Rated Voltage 300V, CAT I	Maximum Rated Voltage 300V, CAT I	Maximum Rated Voltage 600V, CAT III

300kHz/200A AC/DC Current Probe		500kHz/150A AC/DC Current Probe		1MHz/70A AC/DC Current Probe	
					
GCP-300		GCP-500		GCP-1000	
	GCP-300		GCP-500		GCP-1000
Probe Bandwidth	DC~300kHz	Probe Bandwidth	DC~500kHz	Probe Bandwidth	DC~1MHz
Rise Time	1.17μs(Typ.)	Rise Time	0.7μs(Typ.)	Rise Time	0.35 μs (Typ.)
Maximum Continuous Input Range	200A(10mV/A) 20A(100mV/A)	Maximum Continuous Input Range	150A(20mV/A) 15A(200mV/A)	Maximum Continuous Input Range	7A(50mV/A) 70A(500mV/A)
Maximum Peak Current Value	DC : 200A AC : 140Arms	Maximum Peak Current Value	DC : 150A AC : 100Arms	Maximum Peak Current Value	DC : 70A AC : 50Arms
Output Voltage Rate	100mV/A ;10mV/A	Output Voltage Rate	200mV/A;20mV/A	Output Voltage Rate	500mV/A;50mV/A
DC Amplitude Accuracy	±3% ±50 mA at 100 mV/A (50 mA ~ 20A peak range) ±4% ±50 mA at 10 mV/A (500 mA ~ 80A peak range) ±15% max at 10 mV/A (80A peak ~ 200A peak range)	DC Amplitude Accuracy	±3% ±30 mA at 200 mV/A (30 mA ~ 15 A peak range) ±4% ±300 mA at 20 mV/A(300 mA ~ 80 A peak range) ±15% max at 20 mV/A(80A peak ~ 150A peak range)	DC Amplitude Accuracy	±3% ±20 mA at 500 mV/A (20 mA ~ 7A peak range) ±4% ±200 mA at 50 mV/A (200 mA ~ 50 A peak range) ±15% max at 50 mV/A(50A peak ~ 70A peak range)
Maximum Rated Voltage	CAT III 300V/CAT II 600V	Maximum Rated Voltage	CAT III 600V	Maximum Rated Voltage	CAT III 600V

ACCESSORIES		Oscilloscope Education and Training Kit	
(For GDS-300/200 Series)	(For MSO-2000E Series)	CE	
		GDB-03	The GDB-03 training kit allows you to learn both the basic and the advanced functions of the GDS-3000 Series, MSO-2000/GDS-2000A Series and GDS-1000B Series Digital Storage Oscilloscope (DSO). Following the training procedures of this training kit, you will quickly understand the basic operations of a DSO, and the unique features, which represents a typical hi-tech DSO today.
GWS-001 Wrist Strap	GCP-201 Probe Clip , 20PCS		The training kit is a signal generator board capable of producing waveforms, which contain various real-life scenarios you might encounter. With the GDB-03 training kit and the included curriculums, you are able to acquire adequate knowledge in using a DSO with advanced features.
			
GAP-001 AC-DC Adaptor			

ACCESSORIES		
(For GDS-2000A Series)		
		
DS2-16LA 16-Channel Logic Analyzer	DS2-08LA 8-Channel Logic Analyzer	
		
DS2-LAN Ethernet & SVGA Output	DS2-GPIB GPIB Interface	DS2-FGN 5MHz DDS Function Generator



GSP-9330 3.25GHz Spectrum Analyzer
C-1200 IoT LoRa Tester
GSP-818 1.8GHz Spectrum Analyzer

SPECTRUM ANALYZERS

GW Instek's spectrum analyzer product line consists of two series, which are spectrum analyzer and dedicated tester. Both series are ideal for a wide range of test applications, including R&D, service, maintenance, manufacturing, education and other RF application fields.

Spectrum Analyzer Series

There are four spectrum analyzer products featuring frequency ranges from 9 kHz to 1.8 GHz / 3 GHz / 3.25 GHz and providing various measurement application functions such as ASK/FSK/AM/FM demodulation analysis, SEM, ACPR/OCBW/CHPW, TOI, harmonic, CNR/CTB/CSO, frequency counter; and communications interfaces such as USB, RS-232, LAN, MicroSD, GPIB, etc.

GSP-9330 and GSP-9300B are applied spectrum analyzers. GSP-9330's built-in EMI-dedicated feature is one of a kind and it collocates with dedicated test accessories to allow engineers to quickly and accurately identify EMI issues. In order to provide more stable measurement and better signal analysis, GSP-9330 and GSP-9300B has built-in Spectrogram and Topographic display modes to display signal persistence and energy changes via color images. The built-in Sequence function allows users to create and execute the required test procedures directly on spectrum analyzer without using a PC.

GSP-818, a basic spectrum analyzer, features a measurement range up to 1.8 GHz, a 10.4" large display, and an easy-to-upgrade software option ideal for general RF measurement applications. GSP-730 is developed for the educational market and it can collocate with the dedicated RF communications modules GRF-1300/GRF-1300A/USG to conduct courses.

Dedicated Tester Series

There are two dedicated testers, including ASK/FSK Tester and IoT LoRa Tester.

C-1100 ASK/FSK Tester provides analyses on ASK/FSK digital signal applications. For example, products using ASK/FSK technology such as tire pressure monitoring system (TPMS) and remote controller.

C-1200 IoT LoRa Tester is specifically designed to test product applications based on LoRa technology.

Both dedicated testers provide multi-channel design and dedicated PC control software to increase test efficiency and reduce equipment costs. Customized services are available.

PRODUCTS

- 3.25 GHz Spectrum Analyzer
- 3 GHz Spectrum Analyzer
- 1.8 GHz Spectrum Analyzer
- ASK/FSK/TPMS Tester
- IoT LoRa Tester
- RF Training System

3.25GHz Spectrum Analyzer

CE



GSP-9330

- * Frequency Range : 9kHz ~ 3.25GHz
- * 0.025ppm Frequency Stability and 1ppm Aging Rate
- * RBW : 1Hz ~ 1MHz (3dB), 6dB EMI Filter : 200Hz, 9kHz, 120kHz, 1MHz
- * Fastest Sweep Time : 204 μ s
- * Sensitivity : -149 dBm/Hz (@PreAmp on)
- * Built-in Preamplifier, 50dB Attenuator, and Sequence Function
- * Built-in EMC Pretest Function, Quasi-Peak/Average EMI Detect Mode
- * Built-in 2FSK Analysis, AM/FM/ASK/FSK Demodulation & Analysis
- * Built-in P1dB Point, Harmonic, CHPW, OCBW, ACPR, SEM, TOI, CNR, CTB, CSO, N-dB Bandwidth, Noise Marker, Frequency Counter, TDP, Gated Sweep
- * Built-in Spectrogram, Topographic and Split-Window Display Modes
- * Remote Control EMI Measurement Software : SpectrumShot
- * Remote Control Interface : LAN, USB, RS-232
- * Options : Tracking Generator, GPIB Interface

3GHz Spectrum Analyzer

CE



GSP-9300B

- * Frequency Range : 9kHz ~ 3 GHz
- * 0.025ppm Frequency Stability and 1ppm Aging Rate
- * Built-in Preamplifier, 50dB Attenuator, and Sequence Function
- * RBW : 1Hz ~ 1MHz
- * Sensitivity : -149dBm/Hz (@PreAmp on)
- * Built-in AM/FM Demodulation & Analysis
- * Built-in P1dB point, Harmonic, Channel Power, N-dB Bandwidth, OCBW, ACPR, SEM, TOI, CNR, CTB, CSO, Noise Marker, Frequency Counter, Time Domain Power, Gated Sweep
- * Built-in Spectrogram, Topographic and Dual-View Display Modes
- * Remote Control Software : SpectrumShot
- * Remote Control Interface : LAN, USB, RS-232
- * Options : Tracking Generator, GPIB Interface

1.8GHz Spectrum Analyzer

CE



NEW

GSP-818

- * Frequency Range: 9kHz ~ 1.8GHz
- * RBW: 10Hz ~ 3MHz, 10Hz ~ 500kHz in 1-10 steps
- * Sensitivity:-148dBm/Hz Typical@PreAmp On
- * Built-in AM/FM Demodulation
- * Bandwidth Zoom Function
- * Measurement Function: ACPR/OCBW/CHPW, NdB Bandwidth, Freq. Counter, Noise Marker, Limit Line
- * Built-in 20dB Preamplifier Standard
- * Interface: LAN, USB
- * Screen: 10.4" SVGA Output (800x600)
- * Options: Tracking Generator, EMI Filter & Detector (via software keycode)

3GHz Spectrum Analyzer

CE

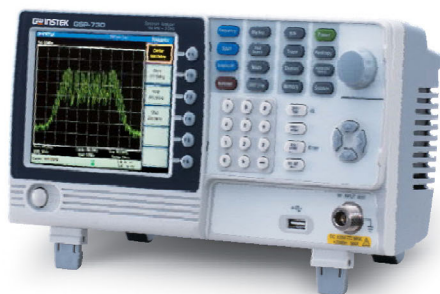

GSP-730

- * Frequency Range : 150kHz ~ 3GHz
- * Autoset Function
- * Noise level : \leq -100dBm
- * RBW Range : 30kHz, 100kHz, 300kHz, 1MHz
- * ACPR/CHPW/OCBW Measurement
- * 3 Traces in Different Colors
- * Split Window Function
- * Limit Line Function
- * Remote Control Software
- * Presentation Material for Training Courses
- * Support Interface : USB Device/Host, RS-232C
- * 5.6" TFT LCD with VGA Output

EMI Pretest Solution - Faster - Easier!

GSP-9330

3.25 GHz Spectrum Analyzer

- * Frequency Range: 3.25GHz
- * EMC Pretest Dedicated Functions
- * Peak, QP, Average Detectors
- * PreAmp, Lin/Log Scale

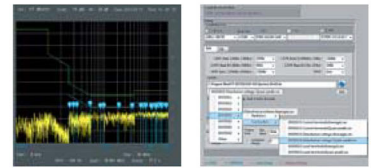

Dedicated PC Software

- * SpectrumShot



GKT-008

EMI Probe Kit Set

- * Sensing Probes: ANT-04, ANT-05
- * Contact Probes: PR-01, PR-02



GLN-5040A

Two Line V-Network



GIT-5060

Isolation Transformer



GPL-5010

Transient Limiter

RF and Communications Trainer

GSP-730 3GHz Spectrum Analyzer/GRF-1300 RF and Communications Trainer



GSP-730

- * Frequency Range : 150kHz ~ 3GHz
- * Autotest Function
- * Noise level : $\leq -100\text{dBm}$
- * RBW Range : 30kHz, 100kHz, 300kHz, 1MHz
- * ACPR/CHPW/OCBW Measurement
- * 3 Traces in Different Colors
- * Split Window Function
- * Limit Line Function
- * Remote Control Software
- * Presentation Material for Training Courses
- * Support Interface : USB Device/Host, RS-232C
- * 5.6" TFT LCD with VGA Output

GRF-1300

- * Waveform Support :
Sine Wave : 0.1 ~ 3MHz
Square Wave : 0.1 ~ 3MHz
Triangle Wave : 0.1 ~ 3MHz
- * RF Frequency : 870 ~ 920MHz
- * AM Modulation & FM Modulation
- * 5 On/Off Switches and 5 Test Points to Simulate 8 Failure Conditions for Learning Outcome Test
- * USB Interface to Provide Remote Control

GSP-730 3GHz Spectrum Analyzer/GRF-1300A RF and Communications Trainer/USG-LF44 RF Signal Generator



GSP-730

- * Frequency Range : 150kHz ~ 3GHz
- * Autotest Function
- * Noise level : $\leq 100\text{dBm}$
- * RBW Range : 30kHz, 100kHz, 300kHz, 1MHz
- * ACPR/CHPW/OCBW Measurement
- * 3 Traces in Different Colors
- * Split Window Function
- * Limit Line Function
- * Remote Control Software
- * Presentation Material for Training Courses
- * Support Interface : USB Device/Host, RS-232C
- * 5.6" TFT LCD with VGA Output

GRF-1300A

- * Waveform Support :
Sine Wave : 0.1 ~ 3MHz
Square Wave : 0.1 ~ 3MHz
Triangle Wave : 0.1 ~ 3MHz
- * RF Frequency : 870 ~ 920MHz
- * AM Modulation & FM Modulation
- * 5 On/Off Switches and 5 Test Points to Simulate 8 Failure Conditions for Learning Outcome Test
- * USB Interface to Provide Remote Control
- * Mixer & 2.4GHz Band Pass Filter

USG-LF44

- * Frequency Range : 34.5MHz ~ 4400MHz
- * Output Power Range : -30dBm ~ 0dBm
- * Continuous Wave Signal Without any Modulation
- * Support Fixed Frequency, Frequency Sweep, Frequency Hopping & Power Sweep Mode
- * -107dBc/Hz Phase Noise @ 100kHz Offset
- * Frequency Resolution : 10kHz
- * PC USB Interface Powered and Controlled
- * External PC Software Support Different Operating System

ASK/FSK/TPMS Tester



NEW

C-1100

- * Four RF Input Channels
- * 315/433 MHz Modulated Output and LF 125 KHz Output
- * Editable Modulation Output and LF Output Contents
- * Two Sets of Trigger Output and One Set of External Trigger Input
- * Multi-display Mode: Spectrum, Modulation Signal Waveform, Symbol, Modulation Parameter
- * ASK/FSK Demodulation Analysis Function
- * 10MHz External Reference Time Base Input
- * Free PC Software With Complete Functions and Multi-display
- * Support FCC and ETSI Test Regulations
- * Support LAN, USB, RS-232 Interfaces
- * Full Remote Control
- * 1U Standard Height



Provide PC Software with Complete Functionalities

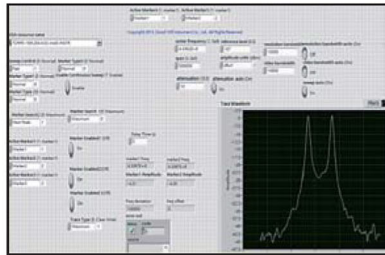

Support LabVIEW Driver

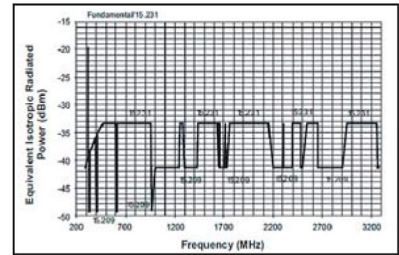

Support FCC 15.231/ETSI 300-220, V3.10 Test Regulations

IoT LoRa Tester



NEW

C-1200

- * 1 Low Power RF TX Port and 3 RF TRX Ports (Switching Type)
- * The Minimum Output Level of Low Power TX Power: -148 dBm
- * Support Full LoRa Test Demand
- * Support LoRa/FSK Modulation Signals
- * Support Sub-GHz and 2.4 GHz
- * Complete PC Software and Built-in MP Test Function
- * Built-in FCC 15.209/15.247 Test Regulations
- * Built-in Temperature Control Calibration Signal
- * Support SPI, UART, I²C Interfaces to Directly Control DUT (Must Collocate With IO Extension, C-1201)
- * Simultaneously Test DUT's Current Consumption (Must Collocate With PPH-1503 DC Power Supply)

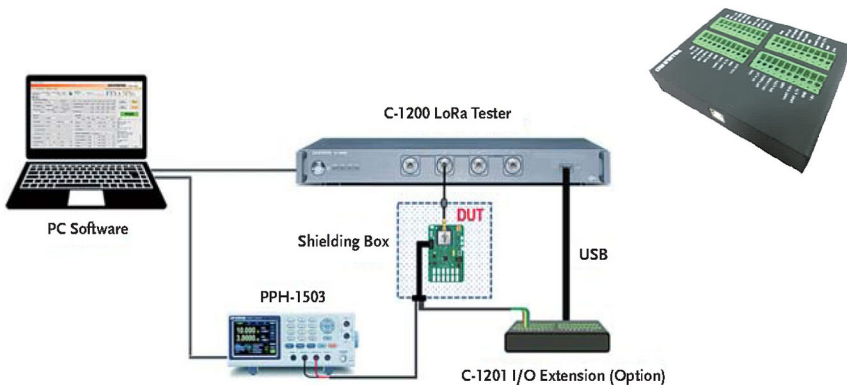

Support LoRa One Station Test

C-1201

I/O Extension

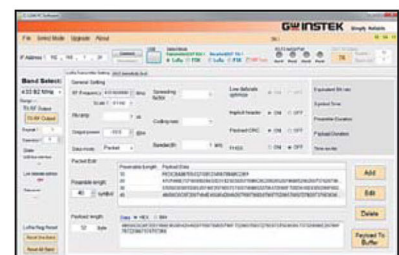

Provide PC Software with Complete Functionalities



AFG-3031/3032/3021/3022 30/20MHz Arbitrary Function Generator
AFG-3081/3051 80/50MHz Arbitrary Function Generator
MFG-2000 Series 10/20/30/60MHz Multi-Channel Function Generator

SIGNAL SOURCES

GW Instek has been one of the major signal source suppliers for worldwide users by providing the advanced-featured products for decades. The wide product lines including MFG(Multi-Channel Function Generator), AFG (Arbitrary Function Generators), RF Signal Generator, DDS (Direct Digital Synthesized) Function Generators, and Analog Function Generators are well provided. MFG-2000 Series is a brand new product of function generator. The special feature is that you can output maximum for five channels simultaneously. It also has RF Generator and the frequency is from 1uHz to 160MHz/320MHz. The most important is isolated design. Output Channels, synchronization and modulation input/output connector grounding are isolated from instrument chassis. The MFG-2000 Series is designed for scientific research and educational applications by the RF Generator and the isolated design. The AFG-3000 Series is designed for industrial, scientific research and educational applications by the high sample rate and the wide frequency bandwidth. The AFG-2000 series is designed to accommodate the educational and basic industrial requirements. The USG Series is a pocket-sized, and USB interface compatible RF signal generator. The SFG-series is a DDS based design for entry level engineering and educational applications. To fit versatile applications, each product line features different frequency ranges and/or specifications to meet the demands.

PRODUCTS

- Arbitrary Function Generator
- Multi-Channel Function Generator
- True Dual Channel Arbitrary Function Generator
- DDS Function Generator
- Analog Function Generator
- RF Signal Generator

Multi-Channel Function Generator

CE



MFG-2200 Series

- * Maximum Five Output Channels
 - 2 Equivalent Performance Arbitrary Channels Frequency:1μHz~30/60MHz
 - RF Channel Frequency(FG/ARB/MOD):160/320MHz
 - Pulse Generator Frequency:25MHz
 - Power Amplifier:Low Frequency,DC~100kHz,20dB/20W (limited by current setting)
- * True Point by Point Output Arbitrary Waveform Function: 200MSa/s,100MHz Repetition Rate,14-bit Resolution, 16k Points Memory Depth * 4.3 Inch TFT Color Display
- * Earth Ground Isolation Design among I/O Terminals and Instrument Chassis
- * Frequency Counter : 150MHz, 8-bit Frequency Resolution
- * AM/FM/PM/ASK/FSK/PSK/SUM/PWM Modulation
- * Built-in Medical and Automotive Electronic Waveforms
- * USB Host/USB Device/LAN

Multi-Channel Function Generator

CE



MFG-2100 Series

- * Maximum Four Output Channels
 - Arbitrary Channel Frequency:1μHz~10/20/30/60MHz
 - RF Channel Frequency(FG/ARB/MOD):160/320MHz
 - Pulse Generator Frequency:25MHz
 - Power Amplifier:Low Frequency,DC~100kHz,20dB/20W (limited by current setting)
- * True Point by Point Output Arbitrary Waveform Function: 200MSa/s,100MHz Repetition Rate,14-bit Resolution, 16k Points Memory Depth * 4.3 Inch TFT Color Display
- * Earth Ground Isolation Design among I/O Terminals and Instrument Chassis
- * Frequency Counter : 150MHz, 8-bit Frequency Resolution
- * AM/FM/PM/ASK/FSK/PSK/SUM/PWM Modulation
- * Built-in Medical and Automotive Electronic Waveforms
- * USB Host/USB Device

Arbitrary Function Generator



AFG-3031/3032/3021/3022

- * 1μHz ~ 20 or 30MHz, 20Vpp, 1 or 2 Channel (s)
- * Arbitrary Waveform 250MSa/s, 16-bit Resolution, 8M Memory Depth
- * Isolation Channel Circuit Design
- * Synchronized Phase Operates up to 6 Units and 12 Channels
- * Harmonic Signal Generator
- * Dual Channel Models Support SUM Modulation, Coupling, Tracking, and Phase Functions
- * Pulse Waveform Parameters Can be Set Independently
- * Built-in AM/FM/PM/FSK/PWM/SUM Modulation, Sweep and Burst Functions
- * Built-in Medical and Automotive Electronic Waveforms
- * Built-in I/Q baseband waveform on AFG-3032/3022
- * Provide USB/LAN/GPIB(Optional) Instrument Control Interface

Arbitrary Function Generator

CE



AFG-3081/3051



- * Wide Frequency Range from 1μHz ~ 80/50MHz
- * 1μHz Frequency Resolution throughout Full Range
- * Standard Waveform : Sine, Square, Triangle, Ramp, Pulse, Noise
- * Built-In AM, FM, PWM, FSK, Sweep, Burst Functions
- * 16bit, 200MSa/s, 1M-Point Deep Arbitrary Waveform
- * Output From Any Section of 1M Point Long Waveforms
- * DWR (Direct Waveform Reconstruction) Capability
- * Arbitrary Waveform Editing PC Software
- * 4.3" High Resolution LCD Display
- * USB, RS-232C, GPIB Standard Interfaces

Arbitrary Function Generator

CE



AFG-2225



- * Wide Frequency Ranges From 1μHz~25MHz (sine wave)
- * Built-in Standard 120MSa/s, 10bit, 4k Points Arbitrary Function for Both Channels
- * True Dual-Channel Output, CH2 Provides the Same Characteristics as CH1
- * Dual-Channel Supports Couple, Tracking, Phase Operations
- * 1% ~ 99% Adjustable Duty Cycle for Square Waveform
- * Built-in Standard AM/FM/PM/FSK/SUM/Sweep/Burst and Frequency Counter
- * USB Host/Device Interface for Remote Control and Waveform Editing

Arbitrary Function Generator

CE



AFG-2100/2000 Series

- * 0.1Hz ~ 25/12/5 MHz with in 0.1Hz Resolution
- * Sine, Square, Ramp, Noise and Arbitrary Waveform
- * 20MSa/s Sampling Rate, 10 bit Vertical Resolution and 4k Point Memory for Arbitrary Waveform
- * 1% ~ 99% Adjustable Duty Cycle for Square Waveform
- * Amplitude, DC Offset and Other Key Setting Information Shown on the 3.5" LCD Screen Simultaneously
- * AM/FM/FSK Modulation, Sweep, and Frequency Counter Functions (AFG-2100 only)
- * USB Device Interface for Remote Control and Waveform Editing
- * PC Arbitrary Waveform Editing Software

DDS Function Generator

CE



SFG-1003/1013

- * DDS Technology and FPGA Design
- * Frequency Range : 0.1Hz ~ 3MHz
- * High Frequency Accuracy : ±20ppm
- * High Frequency Stability : ±20ppm
- * Max. Frequency Resolution : 100 mHz
- * Low Distortion Sine Wave : -55dBc, 0.1 Hz~200 kHz
- * Voltage Display (Only SFG-1013)

Function Generator

CE



GFG-8255A/8250A
GFG-8219A/8217A/8216A/8215A

- * Frequency Range : 0.5Hz ~ 5MHz(GFG-8255A/8250A)
0.3Hz ~ 3MHz(GFG-8219A/8217A/8216A/8215A)
- * Waveforms: Sine, Triangle, Square, Ramp, TTL and CMOS Output
- * Variable DC Offset Control
- * Two-Steps (-20dB x 2) and Variable Attenuator
- * Built-In 6 Digits Counter with INT/EXT Function up to 150MHz/High Resolution (Except GFG-8215A)
- * INT/EXT AM/FM Modulation (GFG-8255A/8219A)
- * LIN/LOG Sweep Mode (GFG-8255A/8219A/8217A)
- * GCV Output for Synchronization (GFG-8219A/8255A)

RF Signal Generator

CE



USG-Series

- * Frequency Range : 34.5MHz ~ 4400MHz
- * Output Power Range : -30dBm ~ 0dBm
- * Continuous Wave Signal Without any Modulation
- * Support Fixed Frequency, Frequency Sweep, Frequency Hopping & Power Sweep Mode
- * -107dBc/Hz Phase Noise@100kHz Offset
- * Frequency Resolution : 10kHz
- * PC USB Interface Powered and Controlled
- * External PC Software Support Different Operating System



ASR-2000 Series Compact Programmable AC/DC Power Source
PFR-100L/100M Fanless Multi-range D.C. Power Supply
PEL-3000E Series Programmable D.C. Electronic Load

POWER SUPPLIES

Stemming from the design and manufacture demands of electronic industries, GW Instek offers diverse power supply product lines to meet users' demand for a variety of applications. Based on different needs, the product lines can be divided into several categories including DC Power Supply, AC Power Source and DC Electronic Load. For DC Power Supply, the products can be briefly categorized by the following types, Linear, Switching, Programmable or Non-programmable, Single or Multiple Outputs, High Precision or Affordable Price, Dual Range and Wide Combinations of Voltage and Current, which can be selected to meet the application requirements.

The new APS-Series AC/DC Power Source is not only a precision AC/DC power source, but also a powerful analyzer, containing abundant features for the testing and characteristic analysis of power supplies, electronic devices, components and modules. In addition to AC/ DC Power Source the APS-Series is fully programmable to simulate different power outputs. Sequence can be created by using arbitrary waveforms as well as voltage or frequency sweeps.

GW Instek offers more than 100 power supply products suitable for the requirements of Electronic Assembly Testing, Education, Component Testing, Wireless Product Testing, Burn-in, Battery-Power Product Testing Automotive, Aerospace industries and so on.

PRODUCTS

- Programmable Linear D.C. Power Supply
- Linear D.C. Power Supply
- Programmable Switching D.C. Power Supply
- Switching D.C. Power Supply
- Compact Programmable AC/DC Power Source
- Programmable A.C./D.C. Power Source
- Programmable Linear A.C. Power Source
- Linear A.C. Power Source
- Programmable D.C. Electronic Load
- D.C. Electronic Load
- Current Shunt Meter

Programmable Linear AC Power Source



APS-7050E/7100E (Without Interface)

- * 4.3-inch TFT-LCD
- * Output Capacity:APS-7050E(500VA,310Vrms,4.2Arms); APS-7100E(1000VA,310Vrms,8.4Arms)
- * Measurement and Test Functions Include VOLT,CURR, PWR,IPKH,FREQ,PF
- * Support a Small AC Current Measurement 2mA~35A, Min. Revolution 0.01mA
- * Reverse Current Alarm Function
- * Automatic Execution of Sequence,Simulate, Program mode and Output Function when the Power is on

Model	APS-7050E	APS-7100E
Power Rating	500VA	1000VA
Output Voltage	0 ~ 310.0Vrms	
Output Frequency	45.00 ~ 500.0Hz	

Programmable Linear AC Power Source



APS-7200/7300

- * 4.3-inch TFT-LCD
- * Output Capacity:APS-7200(2000VA, 310Vrms,16.8Arms); APS-7300(3000VA,310Vrms,25.2Arms)Output Augmentation by Options(0~600Vrms/45~999.9Hz)
- * Measurement and Test Functions Include VOLT,CURR, PWR,SVA,IPK,IPKH,FREQ,PF,CF
- * Reverse Current Alarm Function
- * Automatic Execution of Sequence,Simulate,Program mode and Output Function when the Power is on

Model	APS-7200	APS-7300
Power Rating	2000VA	3000VA
Output Voltage	0 ~ 310.0Vrms	
Output Frequency	45.00 ~ 500.0Hz	

Programmable Switching D.C. Power Supply



PSU-Series (Low Voltage)

- * Voltage Rating:6V/12.5/20/40/60
- * Output Power Rating : 1200W ~ 1520W
- * C.V/C.C Priority; Particularly Suitable for the Battery and LED Industry
- * Series and Parallel Operation (2 Units in Series/4 Units in Parallel Maximum)
- * High Efficiency and High Power Density
- * 19" Rack Mount Size Design

Model	PSU 6-200	PSU 12.5-120	PSU 20-76	PSU 40-38	PSU 60-25
Channel	1	1	1	1	1
Power	1200W	1500W	1520W	1520W	1500W
Voltage	0~6V	0~12.5V	0~20V	0~40V	0~60V
Current	0~200A	0~120A	0~76A	0~38A	0~25A

Programmable Switching D.C. Power Supply



PSU-Series (High Voltage)

- * Voltage Rating:100/150/300/400/600V
- * Output Power Rating : 1500W~1560W
- * C.V/C.C Priority; Particularly Suitable for the Battery and LED Industry
- * Series and Parallel Operation (2 Units in Series/4 Units in Parallel Maximum)
- * High Efficiency and High Power Density
- * 19" Rack Mount Size Design

Model	PSU 100-15	PSU 150-10	PSU 300-5	PSU 400-3.8	PSU 600-2.6
Channel	1	1	1	1	1
Power	1500W	1500W	1500W	1520W	1560W
Voltage	0~100V	0~150V	0~300V	0~400V	0~600V
Current	0~15A	0~10A	0~5A	0~3.8A	0~2.6A

Programmable Multi-Range D.C. Power Supply



PSW-Series (Low Voltage)

- * Voltage Rating:30V/80V/160V, Output Power Rating:360W~1080W
- * C.V/C.C Priority;Particularly Suitable for the Battery and LED Industry
- * 1/2,1/3,1/6 Rack Mount Size Design(EIA/JIS Standard)for 360W,720W,1080W

Model	PSW 30-36	PSW 30-72	PSW 30-108	PSW 80-13.5	PSW 80-27
Channel	1	1	1	1	1
Power	360W	720W	1080W	360W	720W
Voltage	0~30V	0~30V	0~30V	0~80V	0~80V
Current	0~36A	0~72A	0~108A	0~13.5A	0~27A

Model	PSW 80-40.5	PSW 160-7.2	PSW 160-14.4	PSW 160-21.6
Channel	1	1	1	1
Power	1080W	360W	720W	1080W
Voltage	0~80V	0~160V	0~160V	0~160V
Current	0~40.5A	0~7.2A	0~14.4A	0~21.6A

Programmable Multi-Range D.C. Power Supply



PSW-Series (High Voltage)

- * Voltage Rating:250V/800V Output Power Rating:360W~1080W
- * C.V/C.C Priority;Particularly Suitable for the Battery and LED Industry
- * 1/2,1/3,1/6 Rack Mount Size Design(EIA/JIS Standard) for 360W,720W,1080W

Model	PSW 250-4.5	PSW 250-9	PSW 250-13.5	PSW 800-1.44	PSW 800-2.88	PSW 800-4.32
Channel	1	1	1	1	1	1
Power	360W	720W	1080W	360W	720W	1080W
Voltage	0~250V	0~250V	0~250V	0~800V	0~800V	0~800V
Current	0~4.5A	0~9A	0~13.5A	0~1.44A	0~2.88A	0~4.32A

Fanless Multi-range D.C. Power Supply



PFR-100L

- * Constant Power Output for Fivefold Multi-Range(V&I)Operation
- * Natural Convection Cooling Design(Fanless Structure)
- * Preset Memory Function & Output ON/OFF Delay Function
- * CV, CC Priority Mode & Bleeder Circuit Control
- * Adjustable Slew Rate For Voltage and Current
- * Protection : OVP, OCP, AC FAIL and OTP
- * Support Front Panel and Rear Panel Output
- * Built-in USB and RS-232/485 Interface Optional LAN+GPIB
- * Web Server Monitoring and Control
- * External Analog Control and Monitor Function

Model	PFR-100L	PFR-100L-GL
Power(W)	100	100
Voltage(V)	50	50
Current(A)	10	10

Fanless Multi-range D.C. Power Supply



PFR-100M

- * Constant Power Output for Fivefold Multi-Range(V&I)Operation
- * Natural Convection Cooling Design(Fanless Structure)
- * Preset Memory Function & Output ON/OFF Delay Function
- * CV, CC Priority Mode & Bleeder Circuit Control
- * Adjustable Slew Rate For Voltage and Current
- * Protection : OVP, OCP, AC FAIL and OTP
- * Support Front Panel and Rear Panel Output
- * Built-in USB and RS-232/485 Interface Optional LAN+GPIB
- * Web Server Monitoring and Control
- * External Analog Control and Monitor Function

Model	PFR-100M	PFR-100M-GL
Power(W)	100	100
Voltage(V)	250	250
Current(A)	2	2

Programmable Multi-Range D.C. Power Supply



PSB-1000 Series

- * 3.5 Inch TFT LCD Display
- * Voltage Rating : 40V/160V
- * Output Power Rating: 400W~800W
- * Constant Power Output for Multi-Range(V & I) Operation
- * C.V/C.C Priority;Particularly Suitable for the Battery and LED Industry
- * Series & Parallel Operation: 2 Units in Series/4 Units in Parallel
- * Standard Interface : LAN, USB, Analog Control Interface
- * Optional Interface : GPIB
- * High Efficiency and High Power Density
- * Adjustable Slew Rate

Model Number	PSB-1400L	PSB-1800L	PSB-1400M	PSB-1800M
Number of Channel	1	1	1	1
Output Power	400W	800W	400W	800W
Output Voltage	0~40V	0~40V	0~160V	0~160V
Output Current	0~40A	0~80A	0~10A	0~20A



Programmable Switching D.C. Power Supply



**PSB-2400L/PSB-2400L2 (Low Voltage)
PSB-2800L/PSB-2800L2**

- * Output Voltage Rating:0~80V, Output Power Rating:400W~800W
- * Constant Power Output for Multi-Range (V & I) Operation
- * Series and Parallel Operation for Low Voltage Models
- * 90 Degree Angle Rotatable Control Panel
- * Sequence Function Edited by PC will be controlled Through Power Supply Interfaces
- * Standard Interface:RS-232C/USB/Analog Control Interface
- * Optional Interface:GPIB PSB-2800LS (Booster Unit) it could be used with PSB-2800L Only.

Model Number	PSB-2400L	PSB-2800L	PSB-2400L2	PSB-2800L2
Number of Channel	1	1	2	NA
Output Power	400W	800W	800W	800W
Output Voltage	0~80V	0~80V	0~80V x 2CH	80V
Output Current	0~40A	0~80A	0~40A x 2CH	80A

Programmable Switching D.C. Power Supply



PSB-2400H/PSB-2800H (High Voltage)

- * Output Voltage Rating:0~800V, Output Power Rating:400W~800W
- * Constant Power Output for Multi-Range (V & I) Operation
- * Parallel Operation (2 Units in Parallel Maximum)
- * 90 Degree Angle Rotatable Control Panel
- * Sequence Function Edited by PC will be controlled Through Power Supply interfaces
- * Standard Interface:RS-232C/USB/Analog Control Interface
- * Optional Interface:GPIB

Model Number	PSB-2400H	PSB-2800H
Number of Channel	1	1
Output Power	400W	800W
Output Voltage	0~800V	0~800V
Output Current	0~3A	0~6A

Low Noise D.C. Power Supply



PLR-Series

- * Output Voltage Rating:20V/36V/60V; Output Power:360W/720W
- * Low Ripple and Noise(0.5mVrms/10mArms)
- * Fast Transition Recovery Time(100μs)
- * Equipped Power Factor Correction Circuit for AC-input 100~240VAC
- * Maximum 2 units in Series Connections or 3 units in Parallel Connections
- * Select the Setting Digits for Voltage and Current (Coarse/Fine Volume Control)
- * Panel Lock Function/3 set of Preset Function
- * Output Off Timer Function(Range:1 min to 1000 hours & 59mins)
- * CC Priority Function(Prevent Overshoot & Inrush Current)
- * Sequence Function of PC Editing(Max.:1000 steps/Min. step Period:50ms)
- * Protection : OVP, UVP, OCP, Remote Sensing(Terminal Open)
- * External Analog Control Function
- * PC Remote Interface:Standard:RS-232;Optional:GPIB/USB/LAN

Programmable Switching D.C. Power Supply



PSP-Series

- * 3 Step Fan Speed Control
- * LCD Display
- * Output ON/OFF Control
- * OVL/OCL/OTP/OPL Protection
- * Normal, +% & -% Output Operation Key
- * High Efficiency and High Power Density
- * Standard : RS-232C
- * Optional European Type Jack Terminal

Model	PSP-603	PSP-405	PSP-2010
Voltage	0 ~ 60V x 1	0 ~ 40V x 1	0 ~ 20V x 1
Current	0 ~ 3.5A x 1	0 ~ 5A x 1	0 ~ 10A x 1

Programmable Linear D.C. Power Supply



PST-Series

- * High Resolution Triple Output 10mV, 1mA
- * 192 x 128 LCD Display, Simultaneously Shows Settings and Measuring Result
- * Over-Voltage, Over-Current, Over Temperature Protection
- * 100 Sets Memory, Auto Step Running With Timer Setting
- * Provided Auto Series and Parallel Function
- * Standard Interface : RS-232C * Labview Driver
- * Option Interface : GPIB (IEEE-488.2)

Model	PST-3202	PST-3201
Voltage	0 ~ 32V x 2, 0 ~ 6V x 1	0 ~ 32V x 3
Current	0 ~ 2A x 2, 0 ~ 5A x 1	0 ~ 1A x 3

Programmable High Precision D.C. Power Supply



PPH-1503/1503D/1506D/1510D

- * 3.5 inch TFT LCD Display
- * External Relay On/Off Control
- * Front and Rear Panel Output Terminal
- * Key Lock Function & 5 sets of Preset Memory Including Power Output On/Off States
- * High Speed Transient Response Time < 40us within 100mV(for rear output) ; <80us within 20mV)
- * OVP, OCP and OTP Protection
- * PC Remote Control Interface(Standard):USB/GPIB/LAN

Model	PPH-1503	PPH-1503D	PPH-1506D	PPH-1510D
Channel	CH1	CH1	CH1	CH1
Power	45W	45W	36W	36W
Voltage	0-15V or 0-9V	0-15V or 0-9V	0-12V	0-15V or 0-9V
Current	0-3A or 0-5A	0-3A or 0-5A	0-3A	0-3A or 0-5A

Programmable Dual-Range D.C. Power Supply



PSM-Series (Linear Type)

- * High Resolution: 1mV/1mA
- * 0.01% Load/Line Regulation, 350μVrms Ripple
- * Auto Step Running with timer Setting and 100 Sets Memory
- * Safety Design:OVP, OCP & OTP; Output ON/OFF Control
- * Self-Test and Software Calibration
- * High Visible Vacuum-Fluorescent Display
- * Front and Rear Output Terminal * Labview Driver
- * Standard Interface : RS-232C, GPIB

Model	PSM-2010	PSM-3004	PSM-6003
Low Range	0 ~ 8V/20A	0 ~ 15V/7A	0 ~ 30V/6A
High Range	0 ~ 20V/10A	0 ~ 30V/4A	0 ~ 60V/3.3A

Multiple Output Dual Range D.C. Power Supply



SPD-3606 (Switching Type)

- * Three Independent, Isolated Output
- * CH1/CH2 : Dual Range Output of 30V/6A or 60V/3A to Cover Wide Application
- * CH3 Adjustable Output : 0.1~5V/3A
- * High Efficiency Power Conversion (Up to 25% then Traditional Power Supply)
- * Remote Control Output On/Off
- * OVP/OTP
- * Fully Safety Design: Reverse Polarity, CH3 Overload Protection, Safe Output Setting, CC/CV Mode
- * Voltage/Current protection Knob (Option)

Multiple Output Programmable Linear D.C. Power Supply



PPT-1830/3615 & PPE-3323

- * Easy Operation with UP/DOWN Key
- * High Resolution: 10mV, 1mA
- * Over Voltage Protection, Over Current Protection(PPT-Series by Hardware)
- * 50 Sets Memory, Triple Output, Auto Tracking
- * Self Test and Software Calibration
- * Auto Step Running With Timer Setting
- * FRONT/REAR Output and Sense Switch Selectable
- * Auto Series and Parallel Operation
- * IEEE-488.2 and SCPI Compatible Command set
- * GPIB Standard Interface & LabVIEW Driver Software
- * High Stability, Low Drift, 4 Digit Display
- * IEC Safety Regulation

Programmable Linear D.C. Power Supply

CE



PSS-Series

- * High Resolution 10mV, 1mA
- * Over-Voltage, Over-Current, Over Temperature Protection
- * Intelligent Fan Control
- * Built-In Buzzer Alarm
- * Standard Interface : RS-232C
- * Option Interface : GPIB (IEEE-488.2) * Labview Driver (Unable to Install RS-232C and GPIB Simultaneously)
- * Optional European Jack Type Terminal

Model	PSS-2005	PSS-3203
Voltage	0 ~ 20V x 1	0 ~ 32V x 1
Current	0 ~ 5A x 1	0 ~ 3A x 1

Switching D.C. Power Supply

CE



SPS-1230/1820/2415/3610/606

- * Two Digital Panel Meters
- * 0.01 % High Regulation
- * Constant Voltage and Constant Current Operation
- * High Efficiency
- * High Power Density
- * Overload and Reverse Polarity Protection

Model	SPS-1230	SPS-1820	SPS-2415	SPS-3610	SPS-606
Voltage	12V	18V	24V	36V	60V
Current	30A	20A	15A	10A	6A

Isolated Output High Precision Current Shunt Meter

CE



PCS-1000I

- * 6 1/2 Digit Voltage and Current Measurement Resolution
- * Simultaneous Current and Voltage Measurement
- * Five Current Measurement Levels(AC & DC) : 30mA/300mA/3A/30A/300A
- * AC Voltage Measurement Levels : 200mV/2V/20V/200V/600V
- * DC Voltage Measurement Levels : 200mV/2V/20V/200V/1000V
- * Standard : USB & GPIB
- * CE Verification

Multi-output Programmable D.C. Power Supply

CE



GPP-X323 Series

- * Load Function (CC,CV,CR Mode)
- * Setting/Read back Resolution:1mV/0.1mA;0.1mV/0.1mA
- * Low Ripple Noise: $\leq 350\mu V_{rms}/\leq 2mArms$
- * Transient Response Time: $\leq 50\mu s$
- * Sequential Output Function,Built-in 8 Template Waveforms
- * Output Recorder Function,Minimum Interval of 1 Second
- * Standard: RS-232, USB, Ext I/O ;
- Optional: LAN, GPIB+LAN

Model	GPP-1326		GPP-2323			GPP-3323			GPP-4323		
	CH1	CH1	CH2	CH1	CH2	CH3	CH1	CH2	CH3	CH4	
Voltage	0-32V	0-32V	0-32V	0-32V	0-32V	1.8/2.5/3.3/5V	0-32V	0-32V	0-5V	0-15V	
Current	0-6A	0-3A	0-3A	0-3A	0-3A	5A	0-3A	0-3A	0-1A	0-1A	

Multiple Output Programmable Linear D.C. Power Supply

CE



GPD-2303S/3303S/4303S/3303D

- * Digital Panel Control
- * User-Friendly Operation, Coarse/Fine Volume Control
- * Key-Lock & Warning Buzzer
- * Tracking Series and Parallel Mode
- * Smart Cooling Fan Achieving Low Noise
- * Display Resolution: 1mV/1mA(GPD-2303S/3303S/4303S) 100mV/10mA(GPD-3303D)
- * Standard Interface: USB * Output ON/OFF
- * 4 Sets Save/Recall

Model	GPD-2303S			GPD-3303S			GPD-4303S				GPD-3303D		
	CH1	CH2	CH1	CH2	CH3	CH1	CH2	CH3	CH4	CH1	CH2	CH3	
Voltage	0-30V	0-30V	0-30V	0-30V	1.8/2.5/3.3/5V	0-30V	0-30V	0-5V	0-15V	0-30V	0-30V	1.8/2.5/3.3/5V	
Current	0-3A	0-3A	0-3A	0-3A	0-3A	0-3A	0-3A	0-3A or 0-1A	0-1A	0-3A	0-3A	0-3A	

Linear D.C. Power Supply



GPR-U Series

- * 0.01% High Regulation & Low Ripple and Noise
- * Constant Voltage and Constant Current Operation
- * Overload and Reverse Polarity Protection
- * 3 1/2 Digits 0.5" LED Display & Ten-Turn Potentiometer
- * Application for Material and Products Aging
- * Built-In Overvoltage and Overcurrent Tripped Crowbar

Model	GPR-1850HDN	GPR-3520HDA	GPR-6015HDA	GPR-7510HDA	GPR-16H50DA	GPR-25H50DA
Power	900W	700W	900W	750W	800W	750W
Volts	0-18V	0-35V	0-60V	0-75V	0-160V	0-250V
Amps	0-50A	0-20A	0-15A	0-10A	0-5A	0-3A

Model	GPR-35H20DA	GPR-50H15DA	GPR-60H15DA	GPR-100H50DA	GPR-7510HDC	GPR-6015HDC	GPR-3520HDC
Power	700W	750W	900W	500W	750W	900W	700W
Volts	0-350V	0-500V	0-600V	0-1000V	0-75V	0-60V	0-35V
Amps	0-2A	0-1.5A	0-1.5A	0-0.5A	0-10A	0-15A	0-20A

Linear D.C. Power Supply

CE



GPR-H Series

- * 0.01% High Regulation
- * Constant Voltage and Constant Current Operation
- * Internal Select for Continuous or Dynamic Load
- * Low Ripple and Noise & 3 1/2 Digit 0.5" LED Display
- * Overload and Reverse Polarity protection
- * Internal Select for Continuous or Dynamic Load (for GPR-3510HD/GPR-6060D/GPR-7550D)

Model	GPR-0830HD	GPR-1820HD	GPR-3510HD	GPR-6060D
Power	240W	360W	350W	360W
Volts	0 ~ 8V	0 ~ 18V	0 ~ 35V	0 ~ 60V
Amps	0 ~ 30A	0 ~ 20A	0 ~ 10A	0 ~ 6A

Model	GPR-7550D	GPR-11H30D	GPR-30H10D
Power	375W	330W	300W
Volts	0 ~ 75V	0 ~ 110V	0 ~ 300V
Amps	0 ~ 5A	0 ~ 3A	0 ~ 1A

Linear D.C. Power Supply

CE



GPR-M Series

- * 0.01% High Regulation
- * Constant Voltage and Constant Current Operation
- * Internal Select for Continuous or Dynamic Load
- * Low Ripple and Noise
- * Overload and Reverse Polarity Protection
- * 3 1/2 Digit 0.5" LED Display

Model	GPR-1810HD	GPR-3060D	GPR-6030D
Power	180W	180W	180W
Output Volts	0 ~ 18V	0 ~ 30V	0 ~ 60V
Output Amps	0 ~ 10A	0 ~ 6A	0 ~ 3A

Linear D.C. Power Supply

CE



GPS-Series

- * Light and Compact Design
- * 0.01% High Regulation
- * Constant Voltage and Constant Current Operation
- * Remote Control for External Programmability
- * Internal Select for Continuous or Dynamic Load
- * Low Ripple and Noise
- * Overload and Reverse Polarity Protection
- * Series or Parallel Operation
- * Optional European Type Jack Terminal (for GPS-3030/GPS-3030D/GPS-3030DD)

Model	GPS-3030	GPS-1830D	GPS-1850D	GPS-3030D	GPS-3030DD
Power	90W	54W	90W	90W	90W
Volts	0 ~ 30V	0 ~ 18V	0 ~ 18V	0 ~ 30V	0 ~ 30V
Amps	0 ~ 3A	0 ~ 3A	0 ~ 5A	0 ~ 3A	0 ~ 3A

Multiple Output Linear D.C. Power Supply



GPE-X323 Series

- * Setting and Read back Resolution : 100mV/10mA
- * 1,2,3 and 4 Independent Isolated Output
- * 4.3 inch Display With Set View Function
- * Output On/Off Switch
- * Tracking Series and Parallel Operation
- * Remote Control Function in Rear Panel
- * Key Lock Function

Multiple Output Linear D.C. Power Supply



GPS-2303/3303/4303

- * 2, 3 and 4 Independent Isolated Output
- * 0.01% Load and Line Regulation * Low Ripple and Noise
- * Tracking Operation and Auto Series/Parallel Operation
- * Output Voltage and Current Setting When Output Disable (Except for GPS-2303)
- * Fan Speed Control Circuit to Minimize Fan Noise

Triple Output Linear D.C. Power Supply



GPC-3060D/6030D

- * Triple Output & Auto Tracking
- * Auto Series and Parallel Operation
- * Constant Voltage and Constant Current Operation
- * Low Ripple and Noise & 5V, 3A Fixed Output
- * Internal Select for Continuous or Dynamic Load
- * Overload and Reverse Polarity Protection
- * 3 1/2 Digits 0.5" LED Display

Model	GPE-1326				GPE-2323				GPE-3323				GPE-4323				Model	GPS-2303		GPS-3303		GPS-4303				Model	GPC-6030D		GPC-3060D	
Channel	CH1	CH1	CH2	CH2	CH3	CH1	CH2	CH3	CH4	Channel	CH1	CH2	CH1	CH2	CH3	CH1	CH2	CH3	CH4	Model	GPC-6030D		GPC-3060D							
Output Voltage	0-32V	0-32V	0-32V	0-32V	5.0V	0-32V	0-32V	0-5V	0-15V	Voltage	0 ~ 30V	0 ~ 30V	5V Fixed	0 ~ 30V	2.2 ~ 5.2V	8 ~ 15V				Model	GPC-6030D		GPC-3060D							
Output Current	0-6A	0-3A	0-3A	0-3A	5A	0-3A	0-3A	0-1A	0-1A	Current	0 ~ 3A	0 ~ 3A	3A Max.	0 ~ 3A	1A Max.	1A Max.				Power	375W		375W							
Series Operation	-	0-64V	0-64V	-	0-64V	-	-	-	-	Tracking Series Voltage	0 ~ 60V	0 ~ 60V	-	0 ~ 60V	-	-				Series	120V 3A		60V 6A							
Parallel Operation	-	0-6A	0-6A	-	0-6A	-	-	-	-	Tracking Parallel Current	0 ~ 6A	0 ~ 6A	-	0 ~ 6A	-	-				Parallel	60V 6A		30V 12A							

PSW-Series Optional Accessories

PSU-Series Optional Accessories

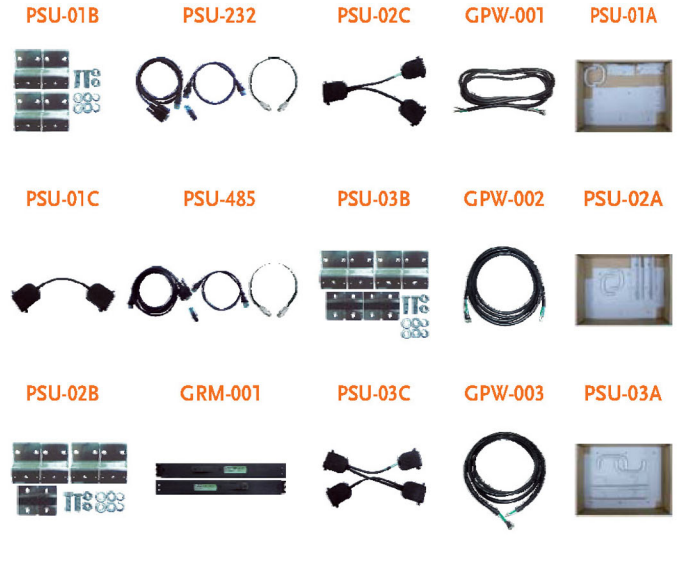

PSB-Series Optional Accessories

PEL-Series Optional Accessories





GPT-12000 Series Electrical Safety Analyzer
GOM-804/805 D.C. Milliohm Meter

LCR-8200 Series High Frequency LCR Meter
GPM-8213 Digital Power Meter

DIGITAL MULTIMETERS/LCR METERS/SAFETY TESTERS/OTHER METERS

The GW Instek Basic Test & Measurement Instruments can be divided into 4 groups: Digital Meters, LCR Meters, Safety Testers and Other Application T&M Instruments.

For Safety testing, GPT-12000/9000 Series safety testers provide you with a safe and quick measurement for AC/DC withstanding voltage tests, insulation resistance tests, and ground bond tests. GLC-9000 leakage current tester supports all the major leakage current test standards for general electrical equipment.

In the Digital Meter group, we provide 6 1/2 digit, 5 1/2 digit and 4 3/4 digit (50000 counts) benchtop multimeters, 4 1/2 and lower digit handheld multimeters as well as a range of mini clamp meters.

LCR Meter includes three series, LCR-8200 Series, LCR-8000G series and LCR-6000 Series. Depending on the model, these series feature frequency of 2kHz ~ 30MHz, and accuracy of 0.05% ~ 0.1%.

In order to provide a complete “one stop shopping” solution, D.C. milliohm meters, Digital power meter, 80V/300V Battery Meter, 120MHz ~ 2.7GHz high frequency counter, automatic distortion meter and A.C. millivolt meters are also provided in this product line of Other application T&M instruments.

PRODUCTS

- Digit Dual Measurement Multimeter
- Digital Multimeter
- Mini Clamp Meter
- LCR Meter
- Handheld LCR Meter
- Logic Probe & Pulser
- Electrical Safety Analyzer
- Electrical Safety Tester
- AC Ground Bond Tester
- Digital IC Tester
- Handy Digital IC Tester
- Automatic Distortion Meter
- D.C Milli-ohm Meter
- Digital Power Meter
- Battery Meter
- Intelligent Counter
- Digital Frequency Counter
- A.C Millivolt Meter

AC/DC/IR/GB Electrical Safety Analyzer

CE



GPT-12000 Series



- * 200VA AC Test Capacity
- * 7" LCD Color Display
- * Capacitive Load Testing Capability Up to 47μF
- * Controllable Ramp Up & Ramp Down Time
- * Statistic Function
- * Testing Time Starting From 0.3s
- * Provide USB Flash Drive Storage Function
- * Universal Power Input

Function	Output Capacity	AC	DC	IR	GB	Continuity	Rear Output
GPT-12001	200VA	✓				✓	✓
GPT-12002	200VA	✓	✓			✓	✓
GPT-12003	200VA	✓	✓	✓		✓	✓
GPT-12004	200VA	✓	✓	✓	✓	✓	✓

AC/DC/IR/GB Electrical Safety Tester

CE



GPT-9900 Series

- * 500VA AC Test Capacity
- * 240 x 64 Ice Blue Dot Matrix LCD
- * Function Key for Quick Selecting
- * Controllable Ramp-up Time
- * Zero Crossing Turn-on Operation
- * True RMS Current Measurement
- * High Intensity Flash for Caution & Status Indication
- * High Resolution : 1μA for Measuring Current, 2V for Setting Voltage
- * PWM Switching Amplifier to Enhance the Power Efficiency and Reliable Testing
- * Max. 100 Memory Block for Test Condition(Step) Setting. And Each Step Can be Named Individually
- * Safety Interlock Function
- * Manual/Auto Mode
- * Interface : RS-232C, USB Device, Signal I/O and GPIB(Optional)
- * Rear Output Available

AC/DC/IR/GB Electrical Safety Tester

CE



GPT-9800 Series

- * 200VA AC Test Capacity
- * 240 x 64 Ice Blue Dot Matrix LCD
- * Function Key for Quick Selecting
- * Controllable Ramp-up Time
- * Zero Crossing Turn-on Operation
- * True RMS Current Measurement
- * High Intensity Flash for Caution & Status Indication
- * High Resolution : 1μA for Measuring Current, 2V for Setting Voltage
- * PWM Switching Amplifier to Enhance the Power Efficiency and Reliable Testing
- * Max. 100 Memory Block for Test Condition(Step) Setting. And Each Step Can be Named Individually
- * Safety Interlock Function
- * Manual/Auto Mode
- * Interface : RS-232C, USB Device, Signal I/O and GPIB(Optional)

Multiplex Scanner Box

CE

Patent No. ZL201420282101.8



GSB-01/02

- * Model : GSB-01 (8CH High Voltage Scanner Box), GSB-02 (6CH High Voltage and 2CH Ground Bond Scanner Box)
- * Multi-channel Outputs for Withstanding Voltage, Insulation Resistance, Ground Bond Tests
- * High-intensity LED for Channel, Status & Judgment Indications
- * Front & Rear Input Connector Design is Suitable for the GPT-9800/9900/9900A Series
- * A Maximum of 4 Scanner Boxes (32 CH) can be Connected to One GPT-9800/9900/9900A Series

AC/DC Withstanding Voltage/Insulation Resistance Tester

CE



GPT-9600 Series

- * 100VA AC Test Capacity
- * 240 x 48 Ice Blue Dot Matrix LCD
- * True RMS Current Measurement
- * ARC Detection
- * Zero Crossing Turn-on Operation
- * PWM Switching Amplifier to Enhance the Power Efficiency and Reliable Testing
- * Automatically Switching Input Source for World-wide Input Voltage
- * Light Design and Easy to Operation

AC Ground Bond Tester

CE



GCT-9040

- * AC 40A Ground Bond Tester
- * Measuring Resistance from 1mΩ-650mΩ
- * Connect with the GPT-9800/9900 Series to Become a Multifunctional Test or Simultaneous Test System
- * 240x64 Ice Blue Dot Matrix LCD
- * Function Key for Quick Selecting
- * High Intensity Flash for Caution & Status Indication
- * PWM Switching Amplifier to Enhance the Power Efficiency and Reliable Testing
- * Max. 100 Memory Block for Test Condition Setting
- * Remote Terminal on the Front Panel for "Start" and "Stop" Remote Active
- * Interface : USB Device, Signal I/O and GPIB (optional)

Leakage Current Tester

CE



GLC-9000

- * Touch Panel with Color LCD Display
- * 9 Different Measuring Devices to Simulate the Resistance of a Human Body
- * 8 Different Types of Leakage Current
- * Various Leakage Current Measuring Modes : DC/AC/AC+DC/AC Peak
- * Upper & Lower PASS/FAIL Limits
- * Meter Function with SELV/CONV Function
- * 50 Preset Test Conditions Conform to the IEC 60990 ; 30 Memories for Customer Defined
- * Standard Interfaces : RS-232C/GPIB/USB Host & Device/EXT I/O

D.C. Milliohm Meter

CE



GOM-804/805

- * 50000 Counts Display
- * TFT 320x240 Color LCD
- * Fast Measurement Rate up to 60 sample/s
- * High Accuracy 0.05%
- * Four-Terminal Measurement
- * Temperature Compensation (TC) Measurement
- * Diode Test
- * Measurement Delay Function
- * Drive Mode: DC+, DC-, Pulsed, PWM, Zero(GOM-805 only)
- * Standard Interface: Handler (D-sub 25P), RS22, USB Device, GPIB(GOM-805 Std./GOM-804 Opt.)

Digital Power Meter

CE



GPM-8213

- * 4" TFT LCD
- * Basic Accuracy : +/- (0.1% of reading + 0.1% of range)
- * Two Data Display Modes
- * Met the requirement of IEC 62301 power measurement
- * Current/Voltage Measurements Reach CF = 3 for Distorted Wave and CF=6 for Half Range
- * Total Harmonic Distortion Measurement
- * W-h Power vs Time Integration Function
- * Front Panel Test Terminal
- * Standard Interfaces : RS-232C, USB Device, LAN



6 1/2 Digit Dual Measurement Multimeter

CE



GDM-906X Series



- * 6 1/2 Digit Display: 1,200,000 Counts
- * 4.3" TFT Graphic LCD
- * DCV Basic Accuracy: 0.0035% (GDM-9061) / 0.0075% (GDM-9060)
- * 12 Measurement Functions: DCV, ACV, DCI, ACI, 2-wire and 4-wire Resistance, Frequency, Period, Diode, Continuity, Temperature and Capacitance
- * Sampling Rate up to 10k SPS (GDM-9061)
- * Dual Measurements to Perform Two Selected Measurement Simultaneously
- * Offer Graphical Capabilities Including Histogram, Bar Meter and Trend
- * Temperature Measurement Support RTD, Thermistor as Well as Thermocouple
- * Standard Interface: USB Host/Device, RS-232C, LAN, Digital I/O
- * Optional Interface: GPIB

6 1/2 Digit Dual Measurement Multimeter

CE



GDM-8261A

- * 6 1/2 Digit Display
- * DCV Basic Accuracy : 0.0035%
- * Dual Measurement to Perform Two Selected Measurements Simultaneously
- * 11 Measurement Functions & 10 Math Functions
- * Measuring Resolution : 100pA for DCI and 1nA for ACI
- * Temperature Measurement
- * Up to 2,400 rdgs/s Data Transmission Speed
- * Standard Interfaces : USB, RS-232C, Digital I/O
- * Optional Interfaces : GPIB or LAN
- * Optional Scanner Card : GDM-SC1
- * PC Software : DMM-Viewer, LabVIEW Driver

5 1/2 Digit Dual Measurement Multimeter

CE



GDM-8351

- * 120,000 Counts, VFD Display
- * Auto/Manual Selection
- * Dual Measurement/Dual Display
- * The Basic Precision of DC Voltage : 0.12%
- * Selectable Measurement Speeds, the Mmaximum: 320 Readings/s
- * True RMS (AC, AC+DC) Measurements
- * 12 Different Measurement Functions: AC/DC Voltage, AC/DC Current, AC+DC Voltage/Current, 2W/4W Resistance, Continuity Beeper, Diode Test, Capacitance, Frequency, Temperature
- * Many Auxiliary Functions : Max./Min., REL/REL#, Compare, Hold, dB, dBm, Math (MX+B, %, 1/X)
- * Digital I/O Provides Dual Mode (Standard Compare and User Definition Modes)
- * Standard RS-232C and USB Device Interface (Support USB CDC and USB TMC Modes)

5 1/2 Dual Display Digital Multimeter

CE



GDM-8255A

- * GDM-8255A : 199,999 Counts Display
- * VFD Two Colors Display
- * 0.012% DCV Accuracy
- * True RMS (AC, AC+DC)
- * 9 Major Measuring Functions and 10 Advanced Measurement Functions
- * 2W/4W Resistance Measurement
- * High Voltage 1000V and 10A Current Range
- * Standard Interface : RS-232C, USB Device, Digital I/O
- * Free PC Software (DMM-VIEWER), LabVIEW Driver
- * Optional 16+2 Channels Scanner Card

50000 Counts Dual Measurement Multimeter

CE

Patent No. ZL201320125978.1



GDM-8341/8342

- * 50000 Counts Vacuum Fluorescent Display with Two Colors
- * Dual Measurement
- * Fast Measurement Rate Up to 40 readings/s for DCV
- * 0.02% DCV Basic Accuracy
- * Auto/Manual Ranging
- * True RMS (AC, AC+DC)
- * 11 Measurement Functions
- * Max./Min., REL, MX+B, 1/X, Ref %, Compare, Hold, dB, dBm
- * Standard USB Device for Communicating to PC
- * Temperature Measurement (GDM-8342 only)
- * USB Storage for Data Collection (GDM-8342 only)
- * Optional GPIB (factory install for GDM-8342 only)

Dual Display Digital Multimeter

CE



GDM-8245 (50000 Counts)

- * 50000 Counts Display
- * Multi-Function ACV, DCV, ACA, DCA, R, C, Hz, Max/Min, Continuity Beeper, Diode Test, REL, Hold, dBm
- * Dual Display Indicate ACV and Hz, DCV (ACV) and dBm
- * Manual or Auto Ranging
- * 0.03% DCV Accuracy
- * ACV Measuring Frequency Up to 50kHz
- * AC True RMS or AC + DC True RMS

Hand-Held Digital Multimeter

CE



GDM-452/357/350B (Manual Range)
GDM-461/397/360/398 (Auto/Manual Range)

- * 22000 Counts Auto/Manual Ranging (GDM-461)
- * 4 1/2 Digits 19999 Counts (GDM-452)
- * 4000 Counts Auto/Manual Ranging (GDM-397/398)
- * 6000 Counts Auto/Manual Ranging (GDM-360)
- * 3 1/2 Digits 1999 Counts (GDM-357/350B)
- * Continuity Beeper/Diode Test
- * High Energy Fuse for 10A Range
- * Data Hold
- * True RMS (GDM-461/360)
- * RS-232C (GDM-461/397/360)

Intelligent Counter



GFC-8270H/8131H

- * GFC-8270H : 0.01Hz ~ 2.7GHz Frequency Range
- * GFC-8131H : 0.01Hz ~ 1.3GHz Frequency Range
- * 10mV rms High Sensitivity
- * 100nHz Resolution for 1Hz
- * Frequency and Period Measurement
- * High Resolution at Both High and Low Frequency
- * Variable Trigger Level Control

Digital Frequency Counter



GFC-8010H

- * 1Hz ~ 120MHz Frequency Range
- * 8 Digit Display (0.3" LED)
- * 15mVrms High Sensitivity
- * 5PPM High Stability Time Base
- * Frequency and Period Measurement
- * Low Pass Filter Function
- * Over-Flow Indicator

Battery Meter

CE



GBM-3300/3080

- * 3.5" TFT LCD (320x240)
- * Measurement Items : DC Voltage and AC Resistance
 - Voltage measurement : 300V (GBM-3300) or 80V (GBM-3080)
 - Resistance measurement : 0mΩ ~ 3.2kΩ(max.)
- * Basic Accuracy For Voltage Measurement : 0.01%
- * Basic Accuracy For Resistance Measurement : 0.5%
- * Measurement Resolution up to 0.1μΩ and 10μV, Suitable For Single-cell Measurement
- * Independent Go/NoGo Determination Function For Voltage and Resistance Respectively
- * The Judgment Mechanism of Test Lead(Probe) Disconnect/Contact Failure is to Ensure The Measurement Reliability
- * Standard Interfaces:USB Host/Device,RS-232C and Handler

A.C. Millivolt Meter

CE



GVT-427B (2 CH)/GVT-417B (1 CH)

- * 300μV Full Scale Sensitivity
- * Measures Frequency From 10Hz ~ 1MHz
- * Measures From -70dB ~ +40dB in 12 Ranges
- * Dual Channel (GVT-427B)
- * CE Approved (GVT-417B)

Automatic Distortion Meter



GAD-201G

- * Automatic Level & Distortion Measurements
- * Auto or Hold Function Can Be Selectable
- * 0.1% ~ 100% in 7 Distortion Measuring Ranges
- * 20Hz ~ 20kHz in 3 Continuous Ranges
- * 400Hz, 1kHz, 10kHz 3 Spot Frequency
- * 1mVrms ~ 300Vrms in 12 ACV Measuring Ranges

High Frequency LCR Meter

CE



LCR-8200 Series

NEW

- * Wide Test Frequency 20Hz~30/20/10/5MHz
- * 0.08% Basic Accuracy
- * 7" LCD Color Display
- * Displaying Four Measurement Results Simultaneously From 17 Selectable Measurement Parameters Freely
- * 15 steps Listed Testing
- * Two Curves Graphic Mode
- * Internal DC Bias Voltage ±12V
- * Standard Interface: RS-232C, GPIB, LAN, Handler, USB Device/Host

Precision LCR Meter

CE



LCR-8000G Series

- * Wide Test Frequency 20Hz~10/5/1MHz
- * 0.1% Basic Accuracy & 6 Digit Measurement Resolution
- * Large LCD Display with Intuitive User Interface
- * Full Measuring Functions with DUT V/I Monitor
- * PASS/FAIL Function with Judgment Alarm
- * DC Resistance Measurement
- * Multi Step Mode
- * Graph Mode
- * Standard RS-232C/GPIB Interface
- * Optional DC Bias box (frequency up to 2MHz max.)

Precision LCR Meter

CE



LCR-6000 Series

- * 3.5" Color LCD, 5 Models(10Hz~2/20/100/200/300kHz)
- * Consecutive Test Frequency & Basic Accuracy : 0.05%
- * Measuring Speed up to 25ms(Max.)
- * Full Frequency Range or Spot OPEN/SHORT
- * 16 Major/Secondary Parameter Measurement Combinations and Two Additional Monitoring Parameters(Maximum Four Different Parameters Can be Shown Simultaneously)
- * DCR Measurement and Internal D.C. Bias Voltage(±2.5V)
- * PASS/FAIL Judgment, Auto Level Control(ALC) Function
- * BIN Function Provides 9BIN and 1AUX, Totally 10 BIN
- * 10 Steps Listed Tests to Select Different Frequency, Voltage and Current Criteria
- * Standard Interface : RS-232C, Handler and USB Storage

Hand Held LCR Meter

CE



LCR-916/915/914 (100kHz/10kHz/1kHz)

- * 20,000/2,000 Counts Dual Display
- * Test Frequency:100/120Hz/1kHz/10kHz/100kHz Depend on Model
- * Auto LCR Mode for DUT Measuring
- * 0.2% Basic Accuracy
- * Auto Range, Auto Backlit
- * Measurement Parameters : L, C, R(AC/DC), D, Q, ESR, θ
- * Parallel/Series Testing Mode
- * Low Battery Indication
- * Sorting Mode for Quality Control
- * Auto Power Off
- * 2Wire or 5Wire Measurement Available
- * Data Hold and Zero Mode Supported
- * Max and Min Mode Supported(LCR-916)
- * Data Collection or DC Power Operation(Optional for LCR-915)

LCR Meter Fixtures

LCR-05



Test fixture for measuring axial and radial lead components
Frequency : DC to 1MHz
Max. Voltage : +/- 35V

LCR-06B



Kelvin clip test lead
Frequency : DC to 1MHz
Max. Voltage : +/- 45V

LCR-07



Test leads for conventional component measurement
Frequency : DC to 1MHz
Max. Voltage : +/- 35V

LCR-08



SMD/chip tweezers
Frequency : DC to 1MHz
Max. Voltage : +/- 35V

LCR-12



Kelvin clip test lead
Frequency : DC to 10MHz
Max. Voltage : +/- 35V

LCR-15



SMD/chip test fixture
Frequency : DC to 10MHz
Max. Voltage : +/- 45V

LCR-16



External DC bias voltage box
Frequency : 40Hz to 1MHz
Max. Voltage : +/- 45V

LCR-17



External DC bias current box
Frequency : 40Hz to 1MHz
Max. Current : +/- 2.5A

DC BIAS BOX



External DC bias voltage box
Frequency : DC to 2MHz
Max. Voltage : +/- 200V

This short form catalog introduces the major GW Instek product lines with a brief explanation of each product. For more information, please visit our website: <http://www.gwinstek.com>

DISTRIBUTOR :

Specifications subject to change without notice.

SF-2020GD1SF_2020-01-4000

Global Headquarters

GOOD WILL INSTRUMENT CO., LTD.

No.7-1, Jhongsing Road, Tucheng Dist., New Taipei City 236, Taiwan
T +886-2-2268-0389 F +886-2-2268-0639
E-mail: marketing@goodwill.com.tw

China Subsidiary

GOOD WILL INSTRUMENT (SUZHOU) CO., LTD.

No. 521, Zhujiang Road, Snd, Suzhou Jiangsu 215011 China
T +86-512-6661-7177 F +86-512-6661-7277

Malaysia Subsidiary

GOOD WILL INSTRUMENT (SEA) SDN. BHD.

No. 1-3-18, Elit Avenue, Jalan Mayang Pasir 3,
11950 Bayan Baru, Penang, Malaysia
T +604-6111122 F +604-6115225

Europe Subsidiary

GOOD WILL INSTRUMENT EURO B.V.

De Run 5427A, 5504DG Veldhoven, THE NETHERLANDS
T +31(0)40-2557790 F +31(0)40-2541194

U.S.A. Subsidiary

INSTEK AMERICA CORP.

5198 Brooks Street Montclair, CA 91763, U.S.A.
T +1-909-399-3535 F +1-909-399-0819

Japan Subsidiary

TEXIO TECHNOLOGY CORPORATION.

7F Towa Fudosan Shin Yokohama Bldg., 2-18-13 Shin
Yokohama, Kohoku-ku, Yokohama, Kanagawa,
222-0033 Japan
T +81-45-620-2305 F +81-45-534-7181

Korea Subsidiary

GOOD WILL INSTRUMENT KOREA CO., LTD.

Room No.503, Gyeonginro 775 (Mullae-Dong 3Ga,
Ace Hightech-City B/D 1Dong), Yeongduengpo-Gu,
Seoul 150093, Korea.
T +82-2-3439-2205 F +82-2-3439-2207

India Subsidiary

GW INSTEK INDIA LLP.

No.2707/B&C, 1st Floor UNNATHI Building,
E-Block, Sahakara Nagar, Bengaluru-560 092. India
T +91-80-6811-0600 F +91-80-6811-0626

GW INSTEK

Simply Reliable



Website



Facebook



LinkedIn